

# INSTALLATION INSTRUCTIONS

## INSTALLER:

Leave this manual with the appliance.

## CONSUMER:

Retain this manual for future reference.

**WARNING:** If the information in these instructions is not followed exactly a fire or explosion may result causing property damage, personal injury or death.

### FOR YOUR SAFETY

Do not store or use gasoline or other flammable vapours and liquids in the vicinity of this or any other appliance.

### WHAT TO DO IF YOU SMELL GAS

- Do not try to light any appliance.
- Do not touch any electrical Switch.
- Do not use any phone in your building.
- Immediately call your gas supplier from a neighbour's phone. Follow the gas supplier's instructions.
- If you cannot reach your gas supplier call the fire department.

Installation and service must be performed by a qualified installer, service agency or the gas supplier.

This appliance may be installed in an after-market permanently located, manufactured home (USA only) or mobile home, where not prohibited by local codes.

This appliance is only for use with the type of gas indicated on the rating plate. This appliance is not convertible for use with other gases unless a certified kit is used.

This appliance is suitable for installation in a bedroom or bed sitting room.



# TOFINO INSTALLATION INSTRUCTIONS



**MODEL: TOFINO i30**

**(SIT Version)**

**SERIES: A**

**DIRECT VENT GAS INSERT**



We endorse



**NATIONAL  
FIREPLACE  
INSTITUTE**  
A CERTIFICATION AGENCY

Visit [www.pacificenergy.net](http://www.pacificenergy.net) for the most recent version of this manual

# Table Of Contents

## Contents

Table Of Contents .....	2
Important Note for the Commonwealth of Massachusetts: .....	3
Caution .....	4
Safety .....	5
First Fire .....	6
Warnings and Cautions .....	6
Fireplace Dimensions .....	7
Tofino Insert Backing Plate Dimensions .....	8
Existing Fireplace Preparation .....	9
Clearances to Combustibles .....	10
Horizontal Clearances.....	10
Objects in front of Appliance .....	10
Mantel Clearances .....	10
Mantel Depth .....	10
Hearth Clearance .....	10
Under Appliance .....	10
Adjustable Leveling Bolts .....	11
Removable Handles .....	11
Venting .....	12
Installation Advisory.....	12
Installation Tip.....	12
Optional 4" to 3" exhaust adapter .....	12
SIT Control Overview .....	14
Door Installation/Removal .....	15
Panel Installation .....	16
Installation.....	17
Baffle .....	18
Cleaning the ceramic glass baffle:.....	18
Installing the ceramic baffle: .....	18
Electrical Supply .....	19
Gas Supply .....	19
Gas Valve for SIT Configuration .....	20
Gas Pressure Check / Output / Efficiency .....	21
Gas Pressure Testing Procedure .....	22
Damper Adjustment .....	23
Damper Adjustment:.....	23
Venturi Adjustment .....	24
Glass Media Installation .....	25
Split Log Set Installation .....	26
Log set Installation.....	27
Manual Switch Installation for SIT Units .....	33
To install ON/OFF Switch .....	33
Pairing the SIT Remote Handset and Receiver .....	35
Surround Installation/Removal Instructions .....	36
Lighting Instructions .....	37
Maintenance .....	38
Glass Door:.....	38
Periodically:.....	38
Wiring Diagram for SIT Proflame .....	39
Tofino i30 Rating Label .....	40
Rating label location .....	41



We recommend that our gas hearth products be installed and serviced by professionals who are certified in the U.S. by the National Fireplace Institute® (NFI) as NFI Gas Specialists.

[www.nficertified.org](http://www.nficertified.org)



**WARNING:** This product can expose you to chemicals including ceramic fibers, which are known to the State of California to cause cancer, and carbon monoxide, which is known to the State of California to cause birth defects or other reproductive harm. For more information go to [www.P65Warnings.ca.gov](http://www.P65Warnings.ca.gov)

This warning is applicable to all  
**Pacific Energy Fireplace Products**

# Important Note for the Commonwealth of Massachusetts:

From Massachusetts Rules and Regulations 248 5.08:

- (a) For all side wall horizontally vented gas fueled equipment installed in every dwelling, building or structure used in whole or in part for residential purposes, including those owned or operated by the Commonwealth and where the side wall exhaust vent termination is less than seven (7) feet above finished grade in the area of the venting, including but not limited to decks and porches, the following requirements shall be satisfied.
1. **INSTALLATION OF CARBON MONOXIDE DETECTORS.** At the time of installation of the side wall horizontal vented gas fueled equipment, the installing plumber or gas fitter shall observe that a hard wired carbon monoxide detector with an alarm and battery back-up is installed on the floor level where the gas equipment is to be installed, in addition, the installing plumber or gas fitter shall observe that a battery operated or hard-wired carbon monoxide detector with an alarm is installed on each additional level of the dwelling, building or structure served by the side wall horizontal vented gas fueled equipment. It shall be the responsibility of the property owner to secure the services of qualified licensed professionals for the installation of hard-wired carbon monoxide detectors.
    - a. In the event that the side wall horizontally vented gas fueled equipment is installed in a crawl space or an attic, the hard-wired carbon monoxide detector with alarm and battery back-up may be installed on the next adjacent floor level.
    - b. In the event that the requirements of this subdivision cannot be met at the time of completion of installation, the owner shall have a period of thirty (30) days to comply with the above requirements; provided, however, that during said thirty (30) day period, a battery operated carbon monoxide detector with an alarm shall be installed.
  2. **APPROVED CARBON MONOXIDE DETECTORS.** Each carbon monoxide detector as required in accordance with the above provisions shall comply with NFPA 720 and be ANSI/UL 2034 listed as IAS certified.
  3. **SIGNAGE.** A metal or plastic identification plate shall be permanently mounted to the exterior of the building at a minimum height of eight (8) feet above grade directly in line with the exhaust vent terminal for the horizontally vented gas fueled heating appliance or equipment. The sign shall read, in print size no less than one-half (1/2) inch in size, "GAS VENT DIRECTLY BELOW. KEEP CLEAR OF ALL OBSTRUCTIONS".
  4. **INSPECTION.** The state or local gas inspector of the side wall horizontally vented gas fueled equipment shall not approve the installation unless, upon inspection, the inspector observes carbon monoxide detectors and signage installed in accordance with the provisions of 248 CMR 5.089(2) (a) 1 through 4.
- (b) **EXEMPTIONS.** The following equipment is exempt from 248 CMR 5.089(2)(a) 1 through 4.
1. The equipment listed in Chapter 10 entitled "Equipment Not Required To Be Vented" in the most current edition of NFPA 54 as adopted by the Board; and
  2. Product Approved side wall horizontal vented gas fueled equipment installed in a room or structure separate from the dwelling, building or structure used in whole or in part for residential purposes.
- (c) **MANUFACTURER REQUIREMENTS – GAS EQUIPMENT VENTING SYSTEM PROVIDED.** When the manufacturer of Product Approved side wall horizontally vented gas equipment provides a venting system design or venting system components with the equipment, the instructions provided by the manufacturer for installation of the equipment and the venting system shall include:
1. Detailed instructions for the installation of the venting system design or the venting system components; and
  2. A complete parts list for the venting system design or venting system.
- (d) **MANUFACTURER REQUIREMENTS – GAS EQUIPMENT VENTING SYSTEM NOT PROVIDED.** When the manufacturer of a Product Approved side wall horizontally vented gas fueled equipment does not provide the parts for venting the fuel gases, but identifies "special venting systems", the following requirements shall be satisfied by the manufacturer.
1. The referenced "special venting system" instructions shall be included with the appliance or equipment installation instructions; and
  2. The "special venting systems" shall be Product Approved by the Board, and the instructions for that system shall include a parts list and detailed installation instructions.
- (e) A copy of all installation instructions for all Product Approved side wall horizontally vented gas fueled equipment, all venting instructions, all parts lists for venting instructions, and/or all venting design instructions shall remain with the appliance or equipment at the completion of the installation.

## Caution

**FOR YOUR SAFETY** - Do not install or operate your Pacific Energy fireplace without first reading and understanding this manual. Any installation or operational deviation from the following instructions voids the Pacific Energy Fireplace Warranty and may prove hazardous.

This appliance and its individual shut off valve must be disconnected from gas supply piping system during any pressure testing of that system at test pressures in excess of 1/2 psig (3.5 kPa).

This appliance must be isolated from the gas supply piping system by closing its individual manual shut off valve during any pressure testing of the gas supply piping system at test pressures equal to or less than 1/2 psig (3.5 kPa).

Note: When lit for the first time, the appliance will emit a slight odour for a couple of hours. This is due to the curing of paints, sealants and lubricants used in the manufacturing process. This condition is temporary. Open doors and windows to ventilate area. Smoke and fumes caused by the curing process may cause discomfort to some individuals.

Do not use the fireplace if any part has been under water. Immediately call a qualified service technician to inspect the fireplace and to replace any part of the control system and any gas control which has been under water.

**This fireplace is equipped with a micro mesh safety screen for your protection and must be installed with the unit. Removal of the safety screen will cause the fireplace to become a burn hazard.**



# DANGER



**HOT GLASS WILL CAUSE BURNS.**

**DO NOT TOUCH GLASS UNTIL COOLED.**

**NEVER ALLOW CHILDREN TO TOUCH GLASS.**

**A barrier designed to reduce the risk of burns from the hot viewing glass is provided with the appliance and shall be installed for the protection of children and other at-risk individuals.**

---

## Safety

---

- Due to high temperatures, this gas appliance should be located out of traffic and away from furniture and draperies.
- Children and adults should be alerted to the hazards of high surface temperatures and should stay away to avoid burns or clothing ignition.
- Young children should be carefully supervised when they are in the same room as the appliance. Toddlers, young children and others may be susceptible to accidental contact burns. A physical barrier is recommended if there are at risk individuals in the house. To restrict access to a fireplace or stove, install an adjustable safety gate to keep toddlers, young children and other at risk individuals out of the room and away from hot surfaces.
- Clothing or other flammable material should not be placed on or near the appliance.
- A barrier designed to reduce the risk of burns from the hot viewing glass is provided with the Surround Kit component and shall be installed.
- If the barrier becomes damaged, the barrier shall be replaced with the manufacturers barrier for this appliance.
- Any grill, panel or door removed for servicing the unit must be replaced prior to operating.
- Installation and repair should be done by a qualified service person. The appliance should be inspected before use and at least annually by a professional service person. More frequent cleaning may be required due to excessive lint from carpeting, bedding material, etc. It is imperative that control compartments, burners and circulating air passageways of the appliance be kept clean.
- This appliance must not be connected to a chimney flue serving a separate solid fuel burning appliance.
- It is our policy that no responsibility is assumed by the Company or by any of its employees or representatives for any damages caused by an inoperable, inadequate, or unsafe condition which is the result, either directly or indirectly, of any improper operation or installation procedures.

### WHAT TO DO IF YOU SMELL GAS

- Do not try to light any appliance.
- Do not touch any electrical Switch.
- Do not use any phone in your building.
- Immediately call your gas supplier from a neighbor's phone. Follow the gas supplier's instructions.
- If you cannot reach your gas supplier call the fire department.
- Installation and service must be performed by a qualified installer, service agency or the gas supplier.

---

## First Fire

---

When lit for the first time, the fireplace will emit a slight odour for a couple of hours. This is due to the curing of paints, sealants and lubricants used in the manufacturing process. This condition is temporary. Open doors and windows to ventilate area. Odour caused by the curing process may cause discomfort to some individuals.

It is normal for fireplaces fabricated of steel to give off some expansion and/or contraction noises during the start up or cool down cycle. Similar noises are found with your furnace heat exchanger or cook stove oven.

**NOTE: Fireplace may take up to 30 seconds to ignite each time the "ON" button has been selected**

---

## Warnings and Cautions

---

### **WARNING**

#### **Fire Hazard. Can cause severe injury or death**

The Receiver causes ignition of the appliance. The appliance can turn on suddenly. Keep away from the appliance burner when operating the remote system or activating manual bypass of the remote system.

### **WARNING**

#### **Shock Hazard. Can cause severe injury or death**

This device is powered by line voltage. Do not try to repair this device. In no way is the enclosure to be tampered with or opened. Disconnect from line voltage before performing any maintenance.

# Fireplace Dimensions

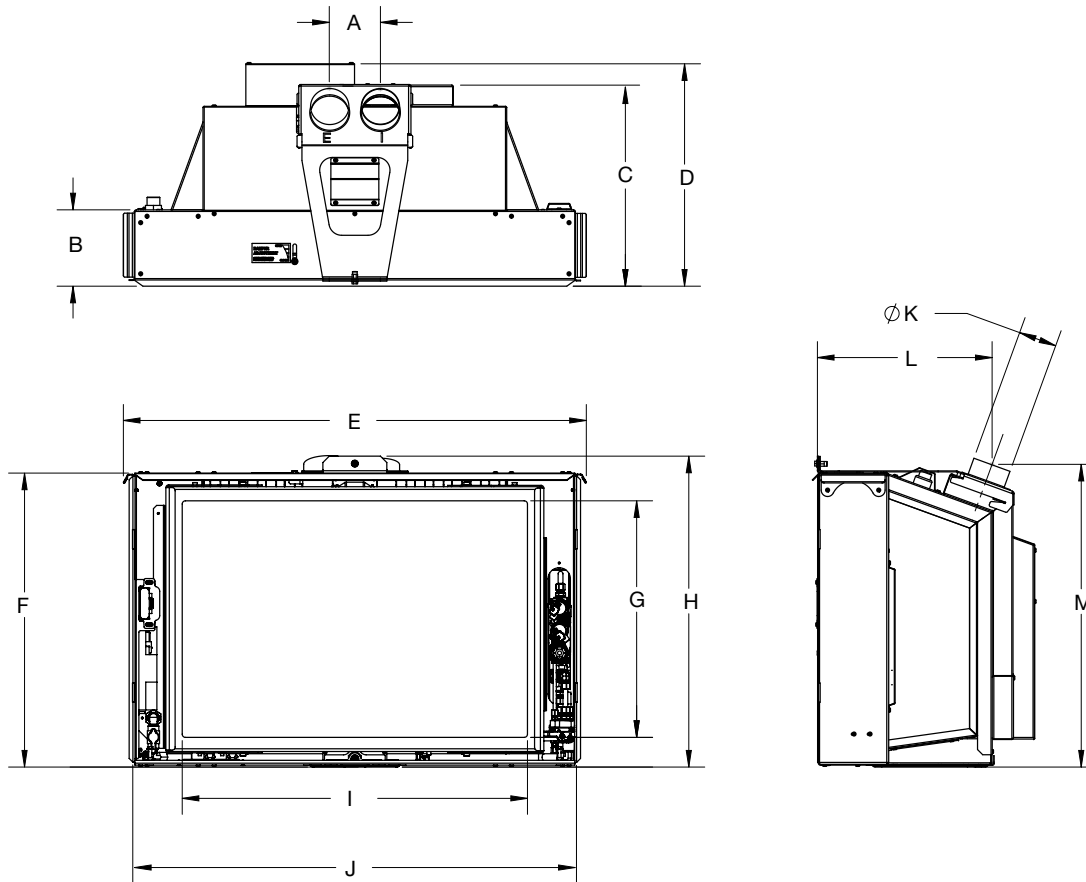

Figure 1: Tofino Dimensions.

	Tofino i30 SIT	Tofino i30 Maxitrol
A	4"	4"
B	6"	6"
C	15 1/4"	15 3/4"
D	17 3/8"	Use dimension "C"
E	33 3/16"	33 3/16"
F	20 3/8"	20 3/8"
G	16"	16"
H	21 5/8"	21 5/8"
I	24"	24"
J	31 1/2"	31 1/2"
K	* 3" x 4"	* 3" x 4"
L	13 5/8"	14 3/8"
M	21 1/4"	21 3/4"

\* This unit ships with a 3" x 4" air intake and exhaust flue adapter.

# Tofino Insert Backing Plate Dimensions

## Tofino i30

HEIGHT / WIDTH	A	B
REGULAR	26"	38"
OVERSIZED	28"	42"

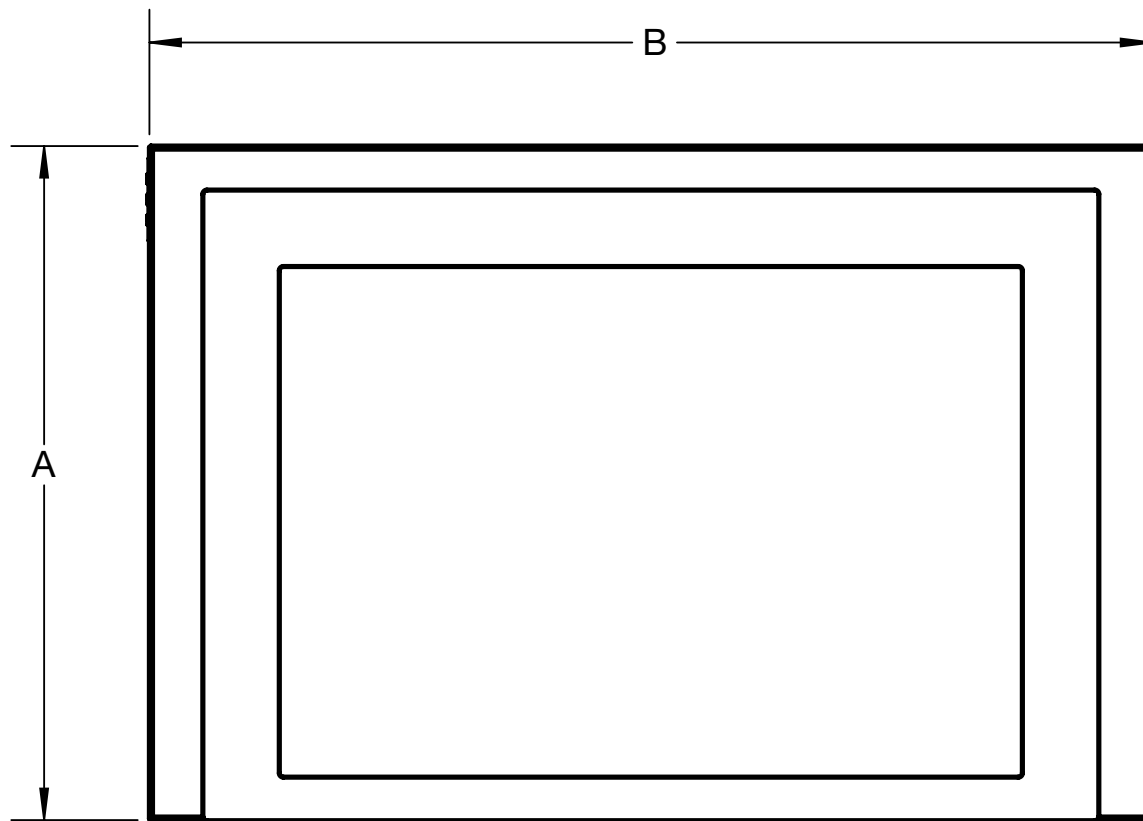

Figure 2: Tofino Surround dimensions.



## Existing Fireplace Preparation

**Note: SIT controlled installations require that an electrical outlet be installed either into an existing fireplace cavity before the Tofino is installed, or alternatively, the power cord can access a pre-existing power outlet elsewhere in the room by way of knock-out openings located on either side of the backing plate. See “Figure 33: Knock-out for power cord.” on page 19.**

The Tofino Gas inserts are certified to be installed into pre-existing approved fireplace. The minimum existing opening fireplace requirements are listed in Figure 3 below.

Dimension	i30 SIT	i30 Maxitrol
A	17 7/8”	16 1/4”
B	22 1/8”	22 1/8”
C without handles	32”	32”
C with handles	33 1/2”	33 1/2”

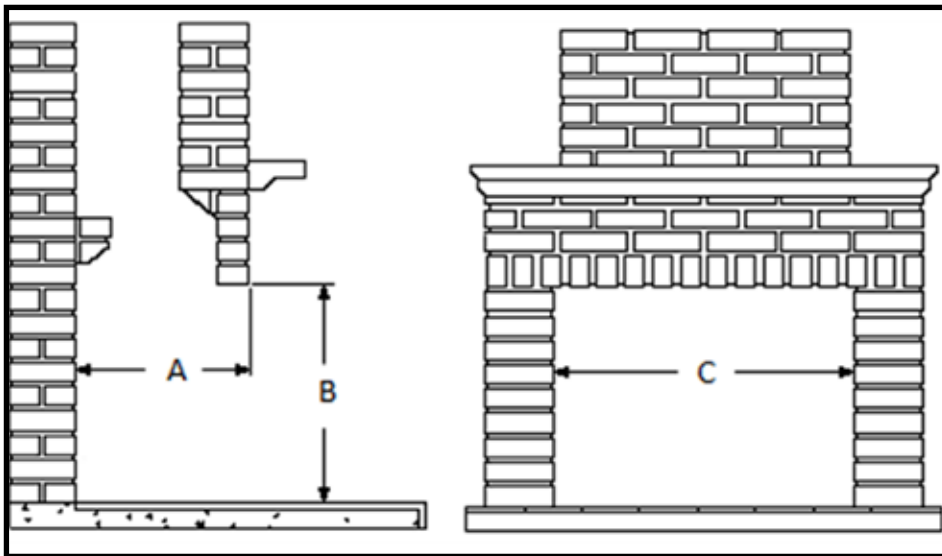

Figure 3: Minimum openings.

Before installing the Tofino inserts, have the chimney and fireplace swept including ash dumps and clean outs. Clean and remove any creosote and soot residue that may cause odors and stains after the insert has been installed. The fireplace chimney should be in good working order and made of non-combustible material. Make sure chimney clean-outs fit properly.

When preparing an existing fireplace to install a gas insert, any modifications that will compromise the integrity of the existing fireplace are not allowed. To make way for the inserts' venting, the fireplace flue dampener may be blocked open or removed. Refractory, glass doors, screen rails, screen mesh and log grates can be removed from the fireplace before installing the insert. Also, smoke shelves, shields and baffles may be removed if attached by mechanical fasteners. Cutting any sheet metal parts of the fireplace, in which the gas fireplace insert is to be installed, is prohibited.

If the factory-built fireplace has no gas access hole(s) provided, an access hole of 1.5” dia. (37.5mm) or less may be drilled through the lower sides or bottom of the firebox in a proper workmanship like manner. This access hole must be plugged with non-combustible insulation after the gas supply line has been installed.

# Clearances to Combustibles

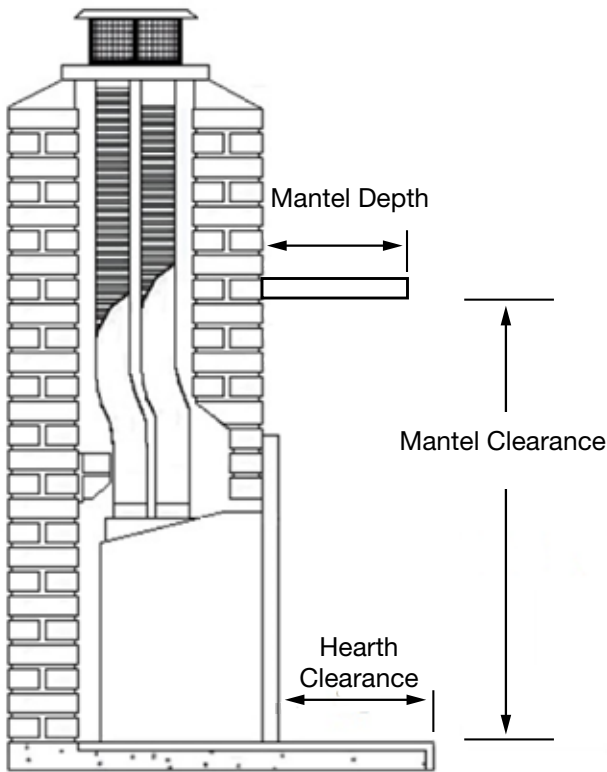

Figure 4: Mantel clearance.

<b>Mantel Clearances</b>	
i30	35"
<b>Mantel Depth</b>	
i30	14"
<b>Hearth Clearance</b>	
i30	0"
<b>Objects in front of Appliance</b>	
i30	36"
<b>Under Appliance</b>	
i30	0"

## Horizontal Clearances

Horizontal clearance to adjacent sidewall combustibles. Refer to Figure 5

i30 18" From center of fireplace to nearest combustible or to backing plate, whichever is furthest

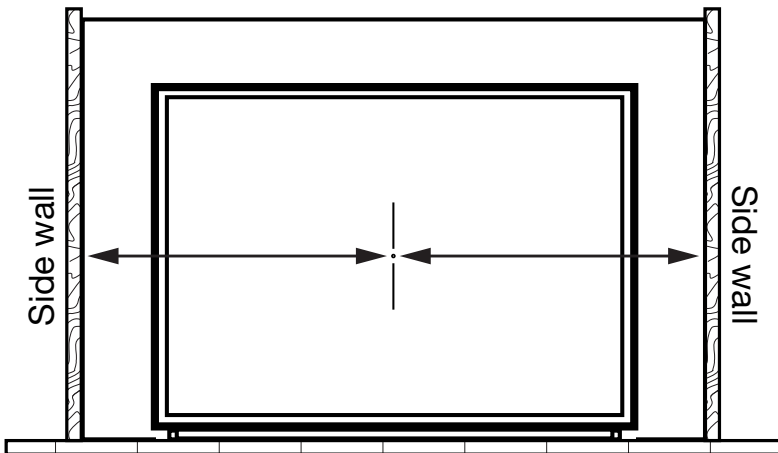

- Fireplace Surrounds and oversize backing plates for larger fireplace openings located on page 8.

Figure 5: Horizontal clearance to combustibles.

## Adjustable Leveling Bolts

### Adjustable leveling bolts

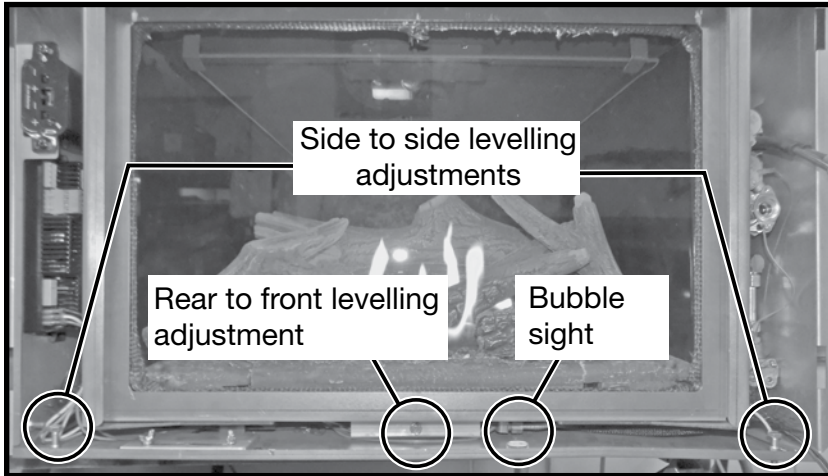

Figure 6: Leveling adjustments.

This fireplace comes with two leveling bolts used to adjust the angle of the front of the fireplace relative to the wall in which it's installed (Figure 6). The bolts are pre-installed. There is also a single rear leveling adjustment bolt located at the center of the bottom floor. Use these adjustments along with the bubble sight (Figure 7) to level the Tofino fireplace.



Figure 7: Bubble sight.

## Removable Handles

The handles used to lift and maneuver the Tofino into position can be removed in order to accommodate a narrower horizontal fireplace opening. By removing each of the two handles, a full 1 1/2" can be saved.

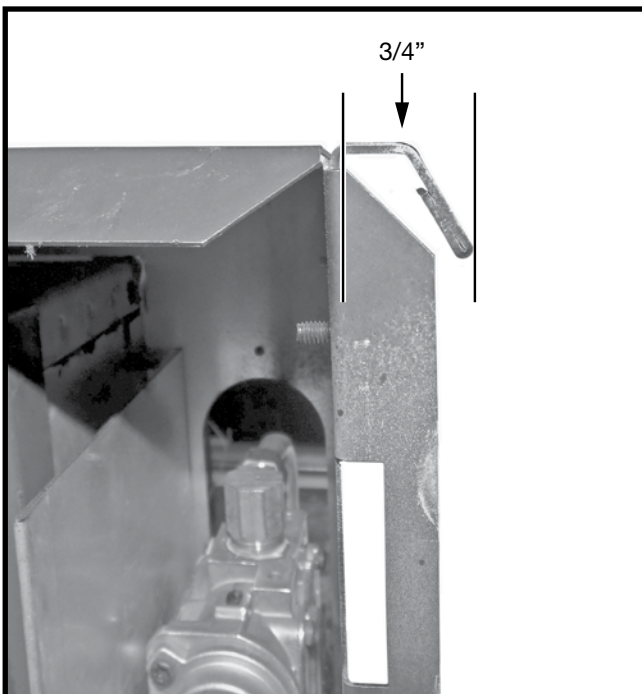

Figure 8: Removable handles.

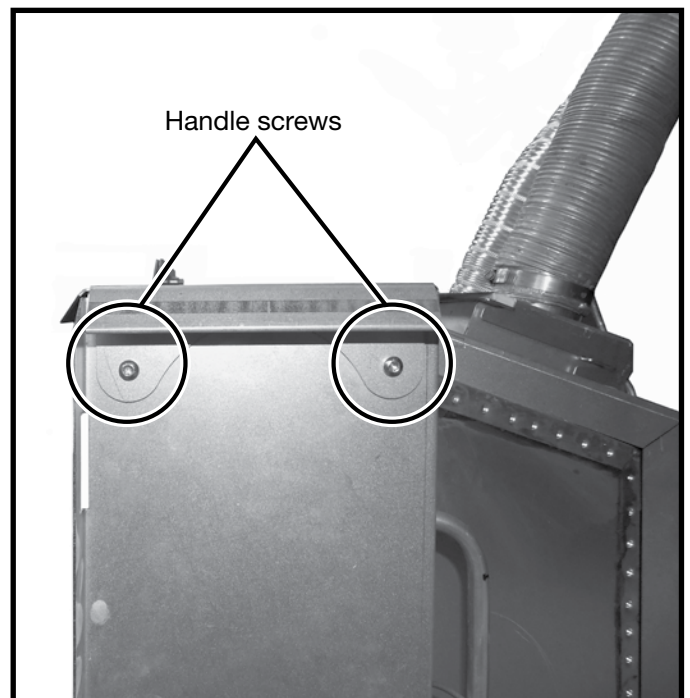

Figure 9: Removable handle screws.

## Installation Advisory

The i30 comes from the factory with a 3" intake and a 4" exhaust configuration. Whenever possible, this configuration should be used. However, a 4" to 3" optional reducer (Figure 11) can be used on the exhaust for venting lengths between 10' and 28' if necessary. Be advised that using this optional adapter may have an impact on flame appearance and is not recommended for use with the glass burner option while operating with propane gas.

10' to 40' Use the 3x4 Configuration
10' to 28' Use the 3x4 and the 4" to 3" adapter Configuration

## Installation Tip

Depending on the amount of room available for the installation of the Tofino, the installer may want to remove the flue adapter and attach it to the flex tubes which will have previously been inserted down the chimney. The installer must make sure that the air intake vent and air exhaust vents attach to the correct ports on both the flue adapter and the vent terminal. The vent terminal and the flue adapter are marked with an "I" (air intake) and "E" (air exhaust).

## Optional 4" to 3" exhaust adapter

Part number for the optional 4" to 3" exhaust adapter is 1227.0003.

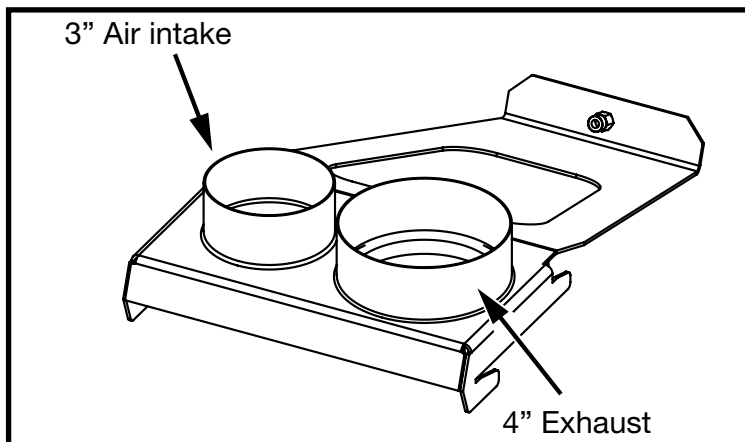

Figure 10: 4 x 3 inch Flue adapter.

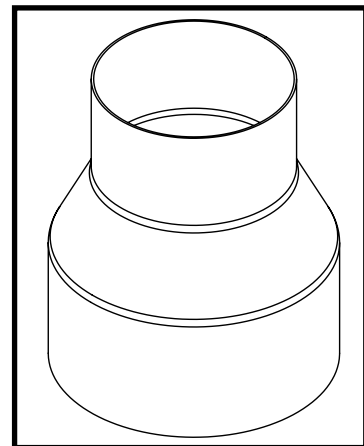

Figure 11: 4 inch to 3 inch exhaust adapter.

Only certified venting systems or components may be installed with this fireplace.

Only the following vent terminals should be used for the Tofino i30.

Manufacturer	Model	Model #	Venting length
Duravent	high wind terminal	DVA-CL33	10' to 28'
Duravent	high wind terminal	DVA-CL34	10' to 40'
ICC	Co linear terminal	CT3	10' to 28'
ICC	Co linear terminal	CT4	10' to 40'

1. Measure chimney height, cut flex liner (min.10') as required. Mark one pipe at both ends to identify combustion air intake pipe from flue outlet pipe.
2. Attach marked flex liner pipe to the intake side of vent terminal. Seal and secure with sealant and screws provided. Attach the other pipe to the outlet side of vent terminal. Seal and secure with sealant and screws provided.
3. Insert both flex liners from top of the chimney, down through the damper opening.
4. Attach and seal according to vent terminal manufacturers' instructions
5. For larger chimneys, a flashing may be cut and fitted to suit. Caulk the flashing in place to seal any gaps.

**Max Vent Height**  
40' (12.2m)

**Min. Vent Height**  
10' (3m)



Combustion Air Intake      Exhaust Vent

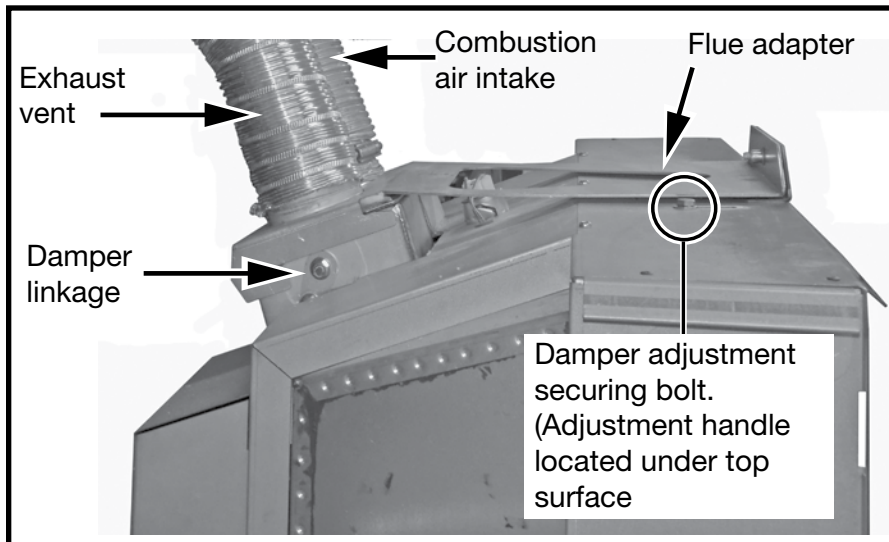

Figure 12: Flue adapter components.

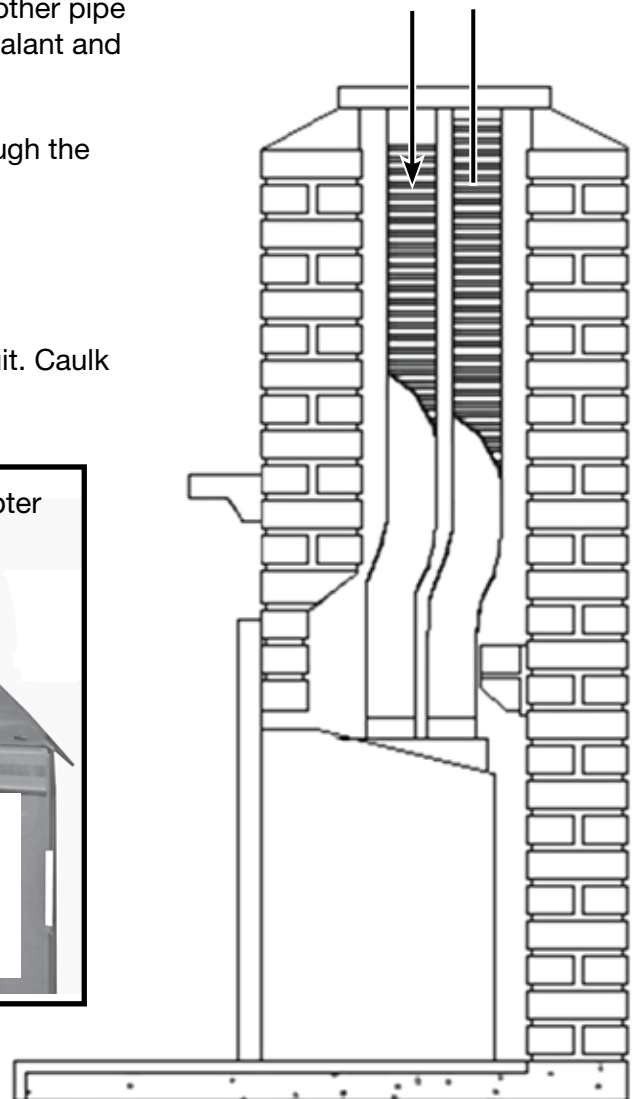

Figure 13: Co linear venting.

## SIT Control Overview

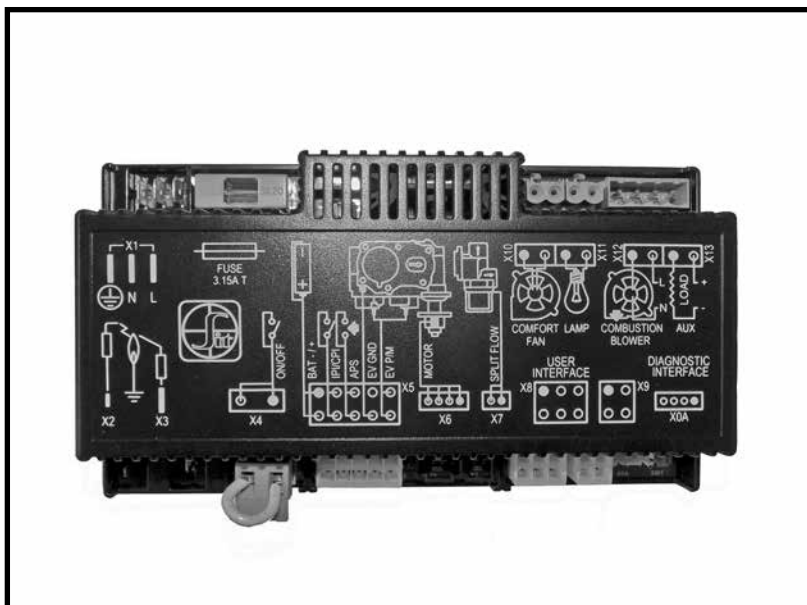

Figure 14: SIT Proflame controller module.



Figure 15: Proflame - SIT remote control device.

The SIT Proflame controller (Figure 14) is used along with the SIT Proflame gas valve (See “Figure 37” on page 20) . The use of the SIT Proflame controller requires a remote control device (provided) unique to the SIT Proflame configuration. Instructions for using the SIT Proflame remote control device are found Tofino Operating Instructions manual. The SIT module uses 4 AA batteries. The SIT Proflame remote control unit uses 3 AAA batteries.

## Door Installation/Removal



Figure 16: Glass door and hooks.

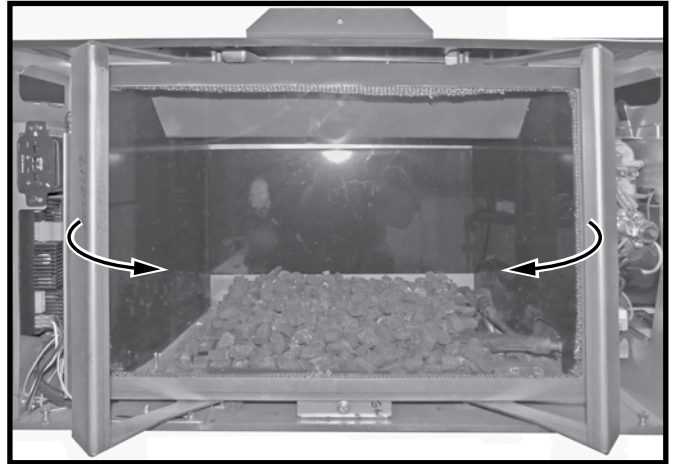

Figure 17: Unlocking the glass door.

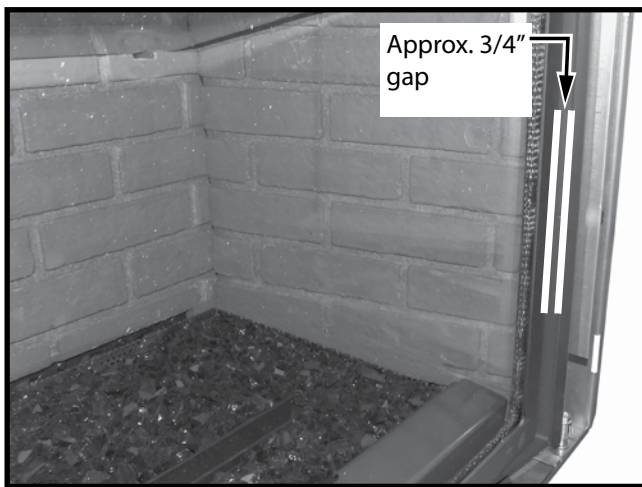

Figure 18: Door handles in closed position.

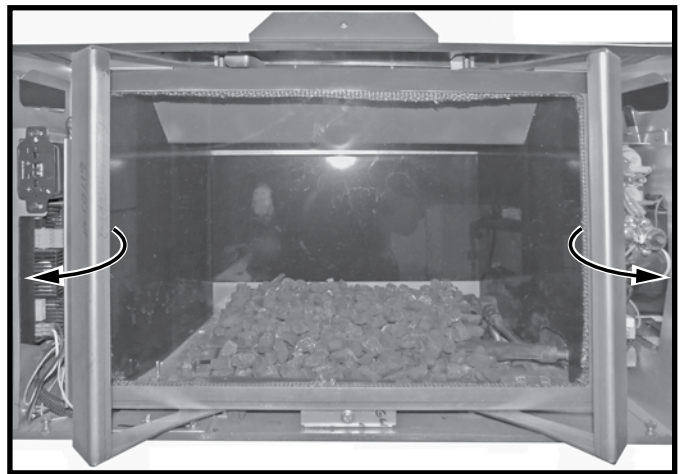

Figure 19: Locking the glass door.

### Removal

1. Remove the decorative front and backing plate from the front of the fireplace, "Surround Installation/Removal Instructions" on page 36. Take care to disconnect the wire on the left hand side of the backing plate which attaches the switch to the interior of the fireplace.
2. There are two handles located on the fireplace door (Figure 16) which must be pulled inward toward the center of the fireplace to unlock the door (Figure 17). This may take some effort because the door completes a tight seal around the firebox.
3. Remove the door and set aside.

### Installation

1. Place the door over the opening of the fireplace.
2. There are two hooks on the top of the handles and two hooks on the bottom of the handle and so the door must be placed squarely over the firebox opening.
3. Once the glass door is seated, close the door handles outward and inward until they stop.
4. The handle will not close completely. There will be an approximately 3/4" gap between the handles and the door frame (Figure 18). This is normal.
5. Return the backing plate to its original position making sure to reconnect the switch wire to the backing plate. Return the surround to its original position.

# Panel Installation

The panel sets are delicate and should be handled with care.

The baffle and panel support bracket (Figure 20) retains the side panels, supports the front end of the ceramic glass baffle, and has a shield which directs the light from the ceiling of the firebox (available on i30s models only) down onto the log set (model dependent). It is held in place by two bolts. The bracket and its bolts should be removed before installing the rear and side panels so that the bolts protruding from the ceiling do not damage the panels.



Figure 20: Baffle and panel bracket.

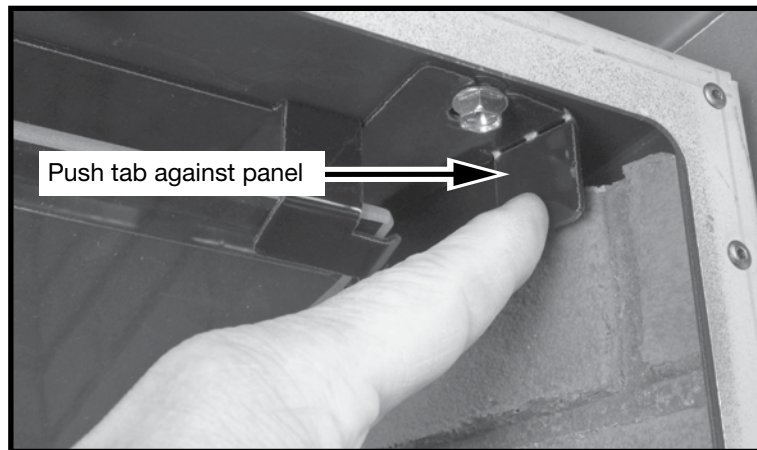

Figure 21: Perforated panel tab.

**Note:** The baffle and panel bracket (Figure 20) has a perforated tab at each end (Figure 21). This allows the tabs to be easily bent against the decorative side wall panels to hold them in place if necessary. Use only enough force to hold the panel in place and not so much as to damage the panel.

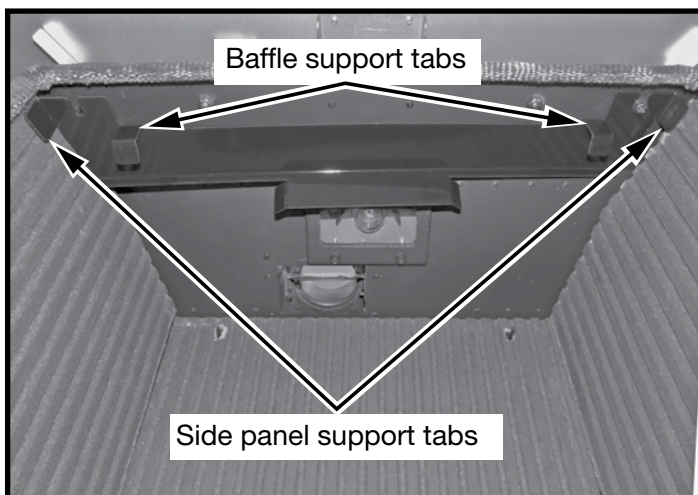

Figure 22: Baffle and panel bracket supporting side panels.

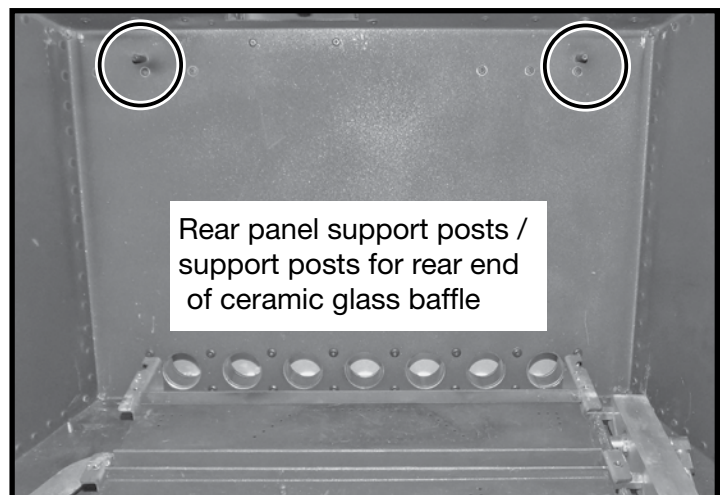

Figure 23: Rear wall showing panel support posts.



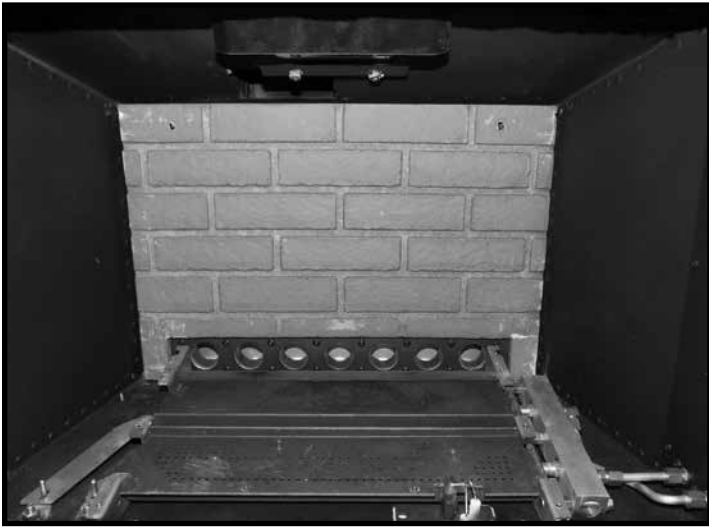

Figure 24: Rear panel in place.



Figure 25: Upper corner.

## Installation

1. With the above mentioned support bracket and bolts removed, hang the rear panel onto the posts protruding from the rear wall (Figure 23 and Figure 24).
2. Gently place the base of either of the two side panels along the edge of the firebox floor and wall. Then slowly tilt the top part of the panels up into the edge of the wall and ceiling. Be careful that the top corner of the panel closest to the front of the fireplace makes as little contact with the opening edge of the firebox (Figure 25) as this may damage the panel.
3. The rear panel is stabilized once the side panels are in place. Stabilize the side panels by installing the glass baffle and panel bracket (Figure 20) and its bolts.
4. Install the ceramic glass baffle as outlined in “Installing the ceramic baffle:” on page 18.



Figure 26: Right side panel in place.



Figure 27: Left side panel in place.

## Baffle

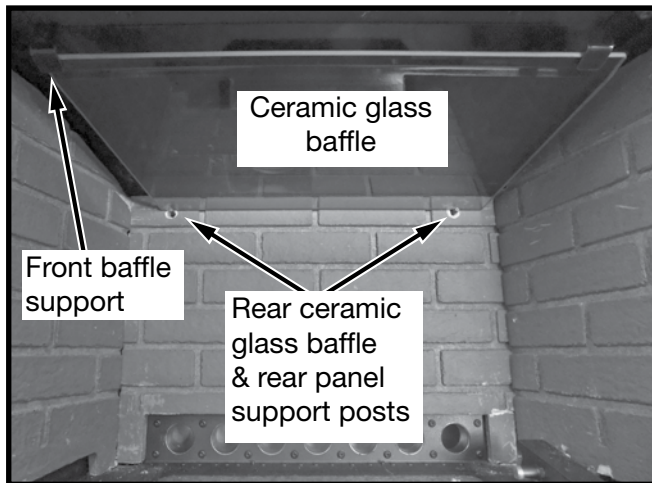

Figure 28: Ceramic glass baffle.



Figure 29: Inserting baffle into the upper corner.

The baffle is made of ceramic glass which allows for the use of a halogen lamp feature. The halogen lamp is only available on units using the SIT Proflame configuration, the Maxitrol configuration does not include the use of a halogen lamp.

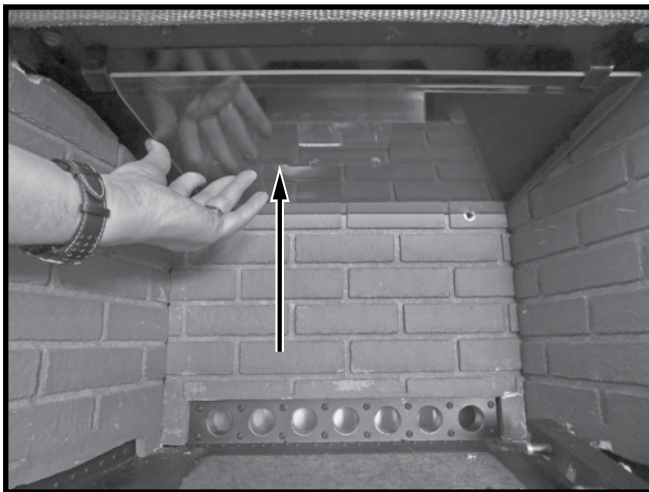

Figure 30: Raising baffle above front support.

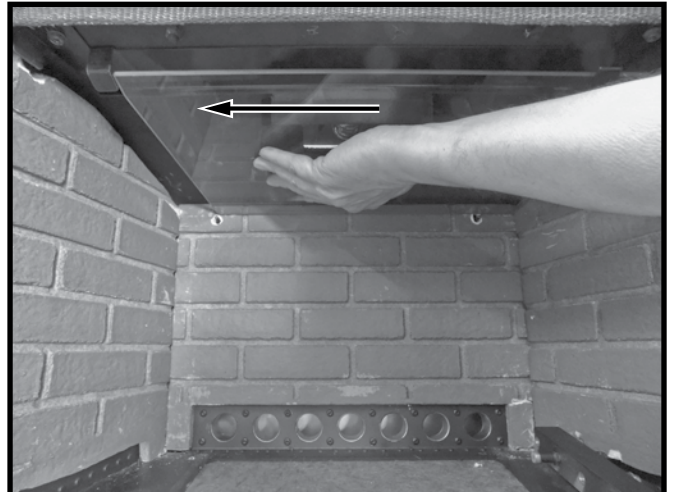

Figure 31: Sliding baffle over to rest on top of supports.

### Installing the ceramic baffle:

1. With the door removed, place one end of the baffle over one of the two upper corners so that the baffle is resting on a rear peg and a front support (Figure 29).
2. Raise the opposite end of the baffle so that it is raised above the supports on the other side of the firebox (Figure 30).
3. Slide the baffle over so that it is supported by all four supports (Figure 31).

### Cleaning the ceramic glass baffle:

Note: Do not clean the ceramic glass baffle until the fireplace has been turned off long enough for the glass door and ceramic baffle to sufficiently cool down. It is not necessary to remove the ceramic baffle in order to clean it but the ceramic baffle is easily removed. Use glass cleaner to clean the ceramic baffle of soot or other debris.

## Electrical Supply



Figure 32: Electrical connection.

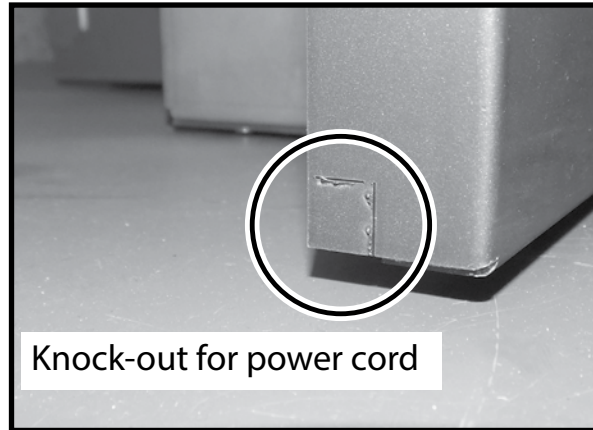

Figure 33: Knock-out for power cord.

**Note: SIT controlled installations require that an electrical outlet be installed either into an existing fireplace cavity before the Tofino is installed, or alternatively, the power cord can access a pre-existing power outlet elsewhere in the room by way of knock-out openings located on either side of the backing plate (Figure 33).**

NOTE: The appliance, when installed must be electrically grounded in accordance with local codes or, in the absence of local codes, with the National Electrical Code, ANSI/NFPA 70, or the Canadian Electrical Code, CSA C22.1.

## Gas Supply

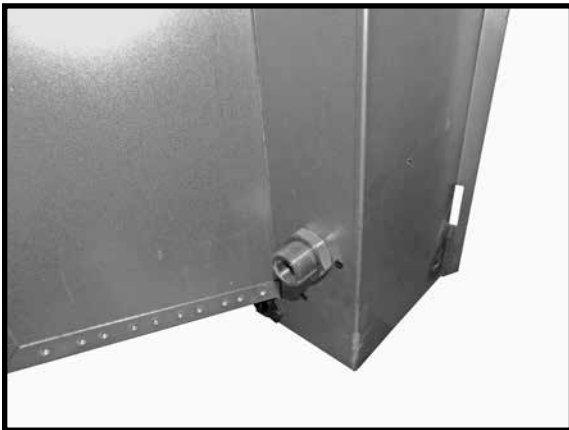

Figure 34: Tofino gas connection.



Figure 35: Gas shut off valve.

Caution: The gas line should be installed by a qualified service person in accordance with all building codes. This section is intended as a guide for qualified technicians installing this appliance. Consult local and/or national building codes before proceeding.

- Gas supply line connection is located on the left rear side of the insert (Figure 34). Gas connection accepts a 3/8" N.P.T. fitting. Correct gas line diameter must be used to assure proper operation and pressure. **Do not use external threads for gas connections. Use internal threads only.**
- A drip leg must be installed in the gas supply line close to the appliance to minimize the possibility of any loose scale or dirt within the gas supply line from entering the control valve.

Check local codes for additional requirements. Turn on the gas supply and check that all connections are tight and leak free.

## Gas Valve for SIT Configuration

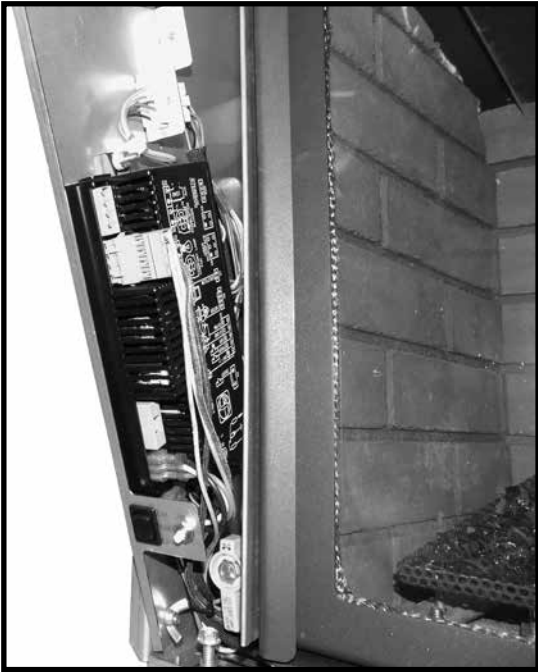

Figure 36: SIT control center.

### SIT controller

The SIT controller is mounted onto a caddy which is located on the left hand side of the fireplace for easy access. Remove the surround to gain access to the controller.



Figure 37: SIT Gas valve.

### SIT gas valve

The SIT gas valve assembly is mounted onto a caddy which is located on the right hand side of the fireplace for easy access. Remove the surround to gain access to the controller.

# Gas Pressure Check / Output / Efficiency

Please refer to following page for gas pressure testing procedure.

<b>SIT Valve</b>		
<b>Gas pressure requirements</b>		
<u>Input Pressure</u>	<u>Natural Gas</u>	<u>Propane</u>
<b>Minimum</b>	<b>5.0" WC</b>	<b>12.5" WC</b>
<b>Maximum</b>	<b>13.9" WC</b>	<b>13.9" WC</b>
<u>Manifold Pressure</u>		
<b>High</b>	<b>3.5" WC</b>	<b>10" WC</b>
<b>Low</b>	<b>1.7" WC</b>	<b>6.4" WC</b>

<b>Tofino i30 (SIT Version)</b>		
<u>Gas</u>	<u>Orifice</u>	<u>Input</u>
NG	Front AB	30,000 btu/hr (Max) / 9,000 btu/hr (Min)
NG	Rear BB	
LP	Front CB	30,000 btu/hr (Max) / 10,500 btu/hr (Min)
LP	Rear DB	

# Gas Pressure Testing Procedure

**Note: To test the gas pressure, turn off the gas supply to the appliance before loosening test point screws. Verify gas pressures with the fireplace lit and at the highest setting.**

1. Remove surround.
2. Locate the inlet and outlet test points on the valve which can be seen in (Figure 38). After locating test ports loosen the cap ends within the ports using a 3/16" Allan key.
3. If necessary, attach brass test extensions to the test ports. Extensions are not included (Figure 40).
4. Attach one end of hoses to brass extensions and the other end to the pressure gauge.
5. Turn gas supply back on and test pressures.
6. After testing is finished turn off gas supply, remove the pressure gauges, apply thread sealant to cap ends and re-tighten (Figure 41).

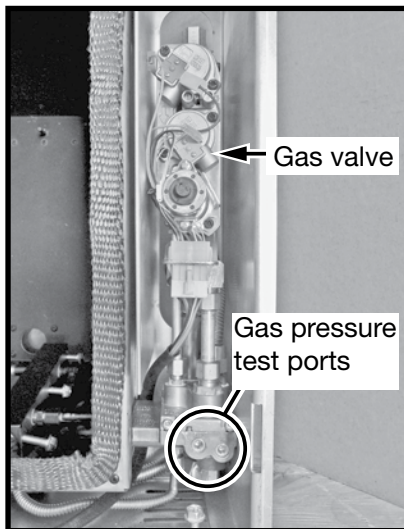

Figure 38: Gas valve location.

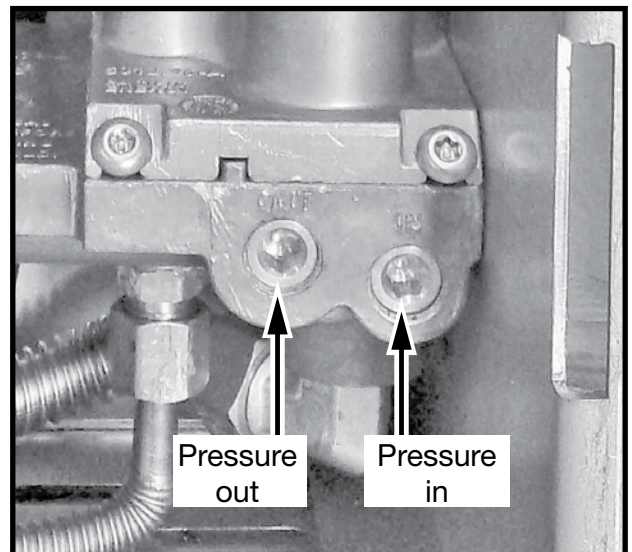

Figure 39: Gas pressure test ports.

Figure 40:  
Installer supplied  
gas valve test port  
extensions.

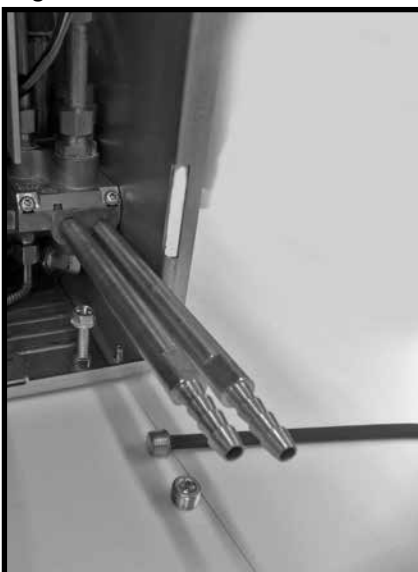

Figure 41: Testing port caps with thread sealant.

# Damper Adjustment

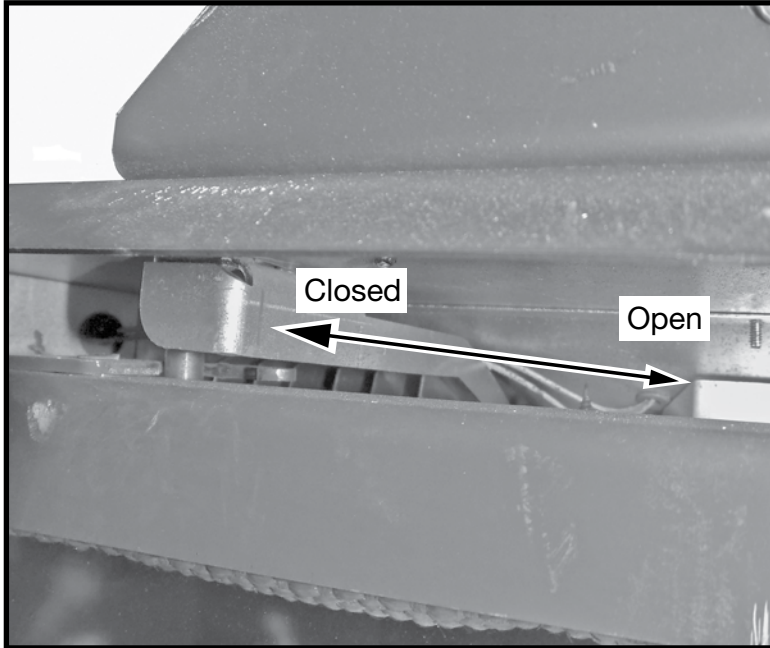

Figure 42: Damper adjustment.

**Note: Be aware that the damper adjustment mechanism may be hot if the fireplace has been burning for any length of time.**

Tofino fireplaces come with an adjustable vent damper. This damper is located behind the air deflector at the rear of the inner firebox. Sometimes on installations that involve vertical venting configurations over 10 feet in height (10 feet is the minimum height), the intake air tends to accelerate down the vent causing hectic flame action. This damper can be closed partially to reduce the speed of the intake air and thus calm the flames to a more natural look. Over-closure of this damper could cause an insufficient air supply to the fire, which would result in flames that cause soot.

## Damper Adjustment:

To adjust the damper, locate the bolt (10 mm or Phillips) on top of the fireplace at the front. Loosen it and adjust the lever directly below the bolt and guide label (Figure 42).

- To close the damper (for a 40' flue), push the adjustment mechanism away from you.
- To open the damper (for a 10' flue), pull the adjustment mechanism toward you.



Figure 43: Damper adjustment indicator.

**This is a guide only. Specific installations may require alternate adjustments.**

# Venturi Adjustment

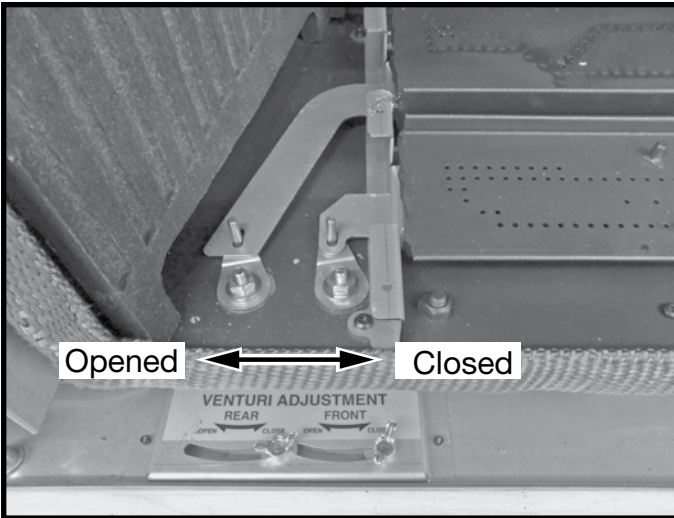

Figure 44: Tofino venturi adjustments.

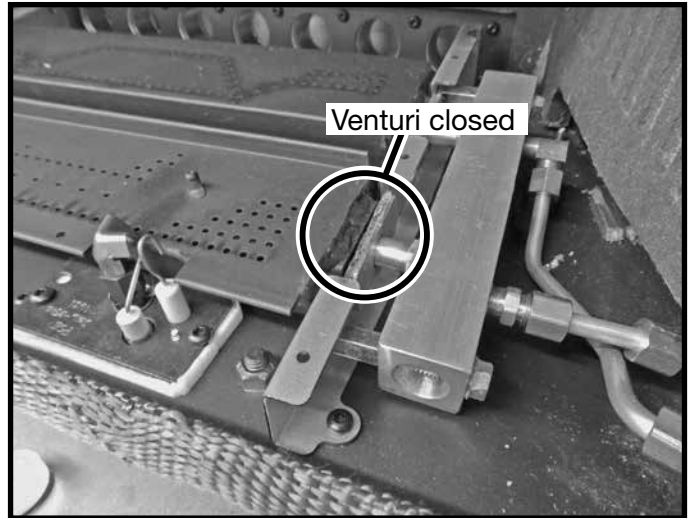

Figure 45: Venturi closed.

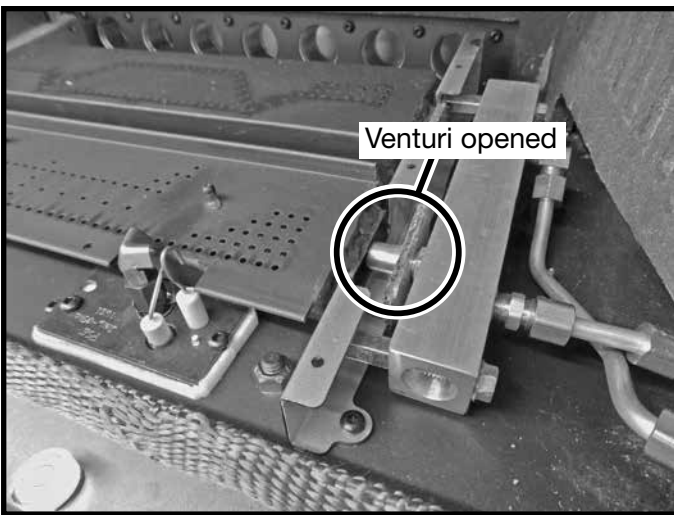

Figure 46: Venturi opened.

The Tofino has two burners and therefore, two venturis. The venturis are easily accessible and adjustable without having to remove the door.

To adjust the venturis:

1. With the fireplace turned off, check that the surround is cool to the touch.
2. Remove the surround from the fireplace.
3. With the fireplace turned on, use the adjustments to adjust for flame appearance.

Note:

The venturi settings on the Tofino i30 units come preset from the manufacturer. Units that use natural gas come with the venturi adjustment set at the fully closed position while units that are configured for propane gas have their venturi adjustment set at the fully open position. It may be necessary for the installer to make a minor adjustment, whether using a natural gas model or a propane gas model, to achieve the desired flame pattern and/or to eliminate sooting.



## Glass Media Installation

1. With the interior panels and the ceramic glass baffle installed, place the burner tray (Figure 47) inside and over the burners and secure in place (total of 10 screws to be used). Place the decorative front edge plate (Figure 48) so that it hooks over the edge of the burner tray. This plate does not fasten to anything and simply rests in place.
2. Add a thin layer of crushed glass on top of the burners and the burner tray (Figure 50). When placing the crushed glass on the burner tray, leave enough room around the pilot and rectifier flame so that it is not impeded. **Avoid dumping entire contents of bag onto the burner tray as fine glass particles at the bottom of the bag can block burner ports and hamper the function of the venturi mechanism.**
3. Keep the gap between the two burners free from all crushed glass (Figure 50). This gap is required for air flow.

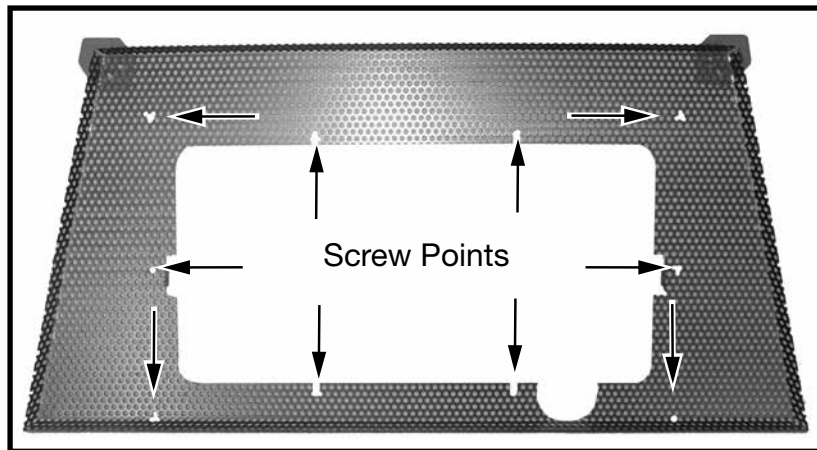

Figure 47: Glass burner tray and screw down points.



Figure 48: Front edge plate.



Figure 49: Burner with empty burner tray.

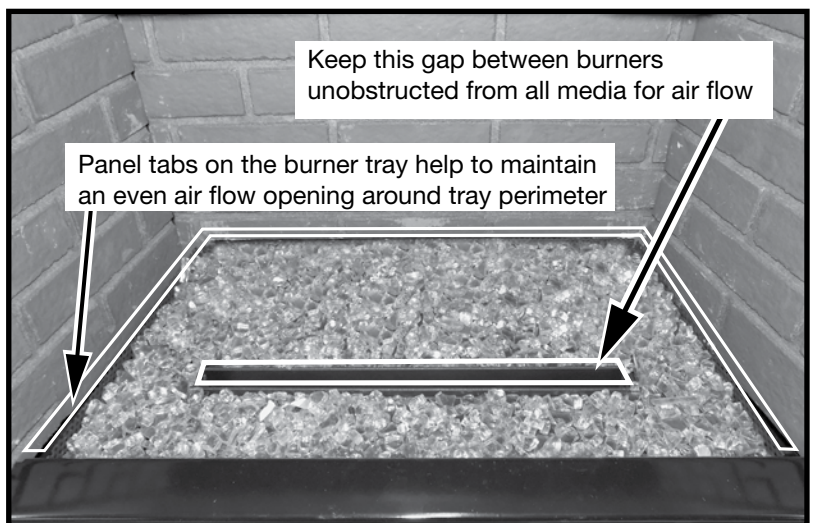

Figure 50: Crushed glass layer.

# Split Log Set Installation

Left side  
base piece



Right side  
base piece



Front base piece



Figure 51: Log set base pieces.



Figure 52: Log number 1.



Figure 53: Log number 2.



Figure 54: Log number 3.



Figure 55: Log number 4.



Figure 56: Log number 5.



Figure 57: Log number 6.



Figure 58: Ember pieces.



Figure 59: Ember wool.

## Log set Installation

**Note:** Panel set must be installed before the Split log set installation begins.

1. Begin by placing the air deflector / 1st log support (Figure 60) behind the rear burner and up against the rear wall (Figure 61). Position so that the lip faces toward the front of the fireplace. Fasten the deflector down with supplied screws. Once the deflector is secured, there should be a gap of approximately 1/2 inch between the deflector and the rear burner (Figure 62). This gap is required for air flow. Also secure the Ember pieces Retainer (Figure 60) along the back of the rear burner. This will help to keep the ember pieces from spilling over from the burner and down into the air gap.
2. Place the right side mesh guard (Figure 63) on the right of the burners and secure with supplied screws (Figure 64).

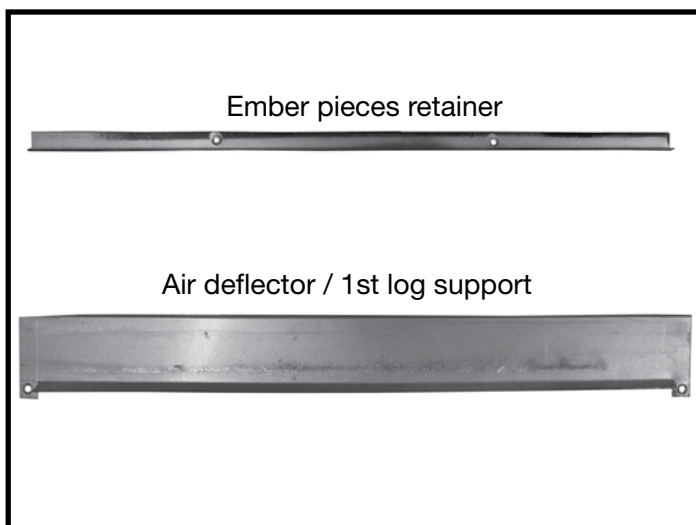

Figure 60: Ember pieces retainer and air deflector-1st log support.



Figure 61: Air deflector.

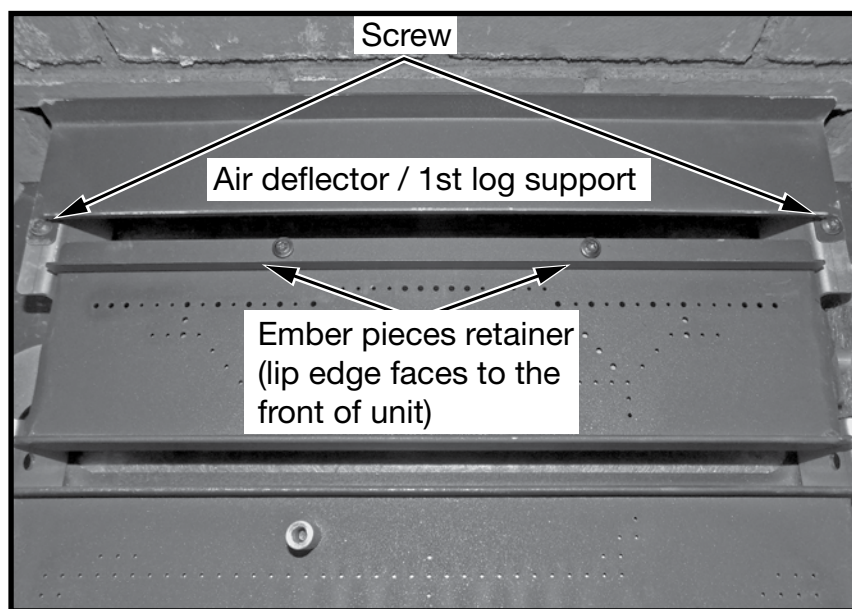

Figure 62: Gap between air deflector and burner.

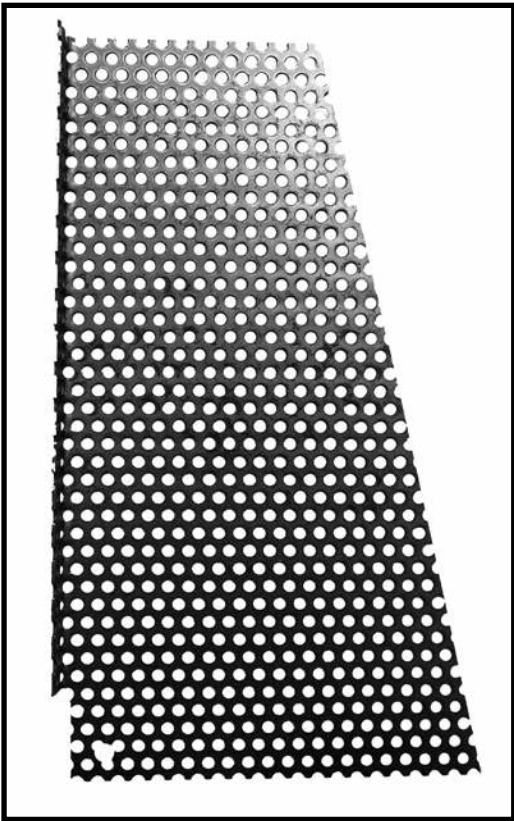

Figure 63: Right side mesh guard.



Figure 64: Right side mesh guard in place.

3. Place the front mesh guard (Figure 65) along the leading edge of the front burner as shown in (Figure 66) and secure with supplied screws.

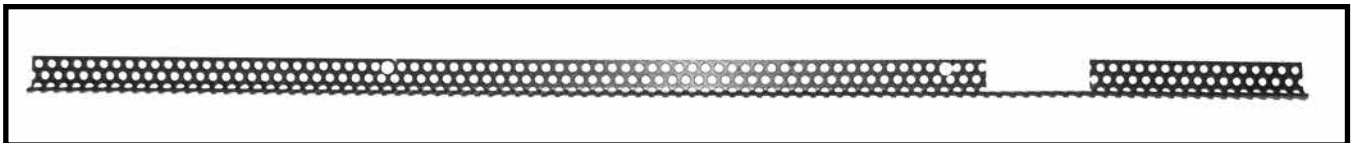

Figure 65: Front mesh guard.

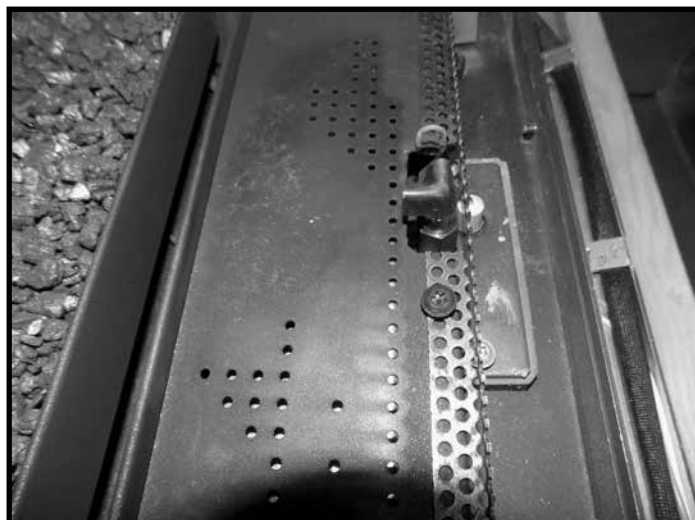

Figure 66: Front mesh guard in place.



Figure 67: Front base piece.



Figure 68: Installing left side base piece.

4. Install the front base piece (Figure 51) as shown in Figure 67. Make sure that indent on the bottom inside edge fits over the pilot assembly.
5. Install the left side base piece (Figure 51) as shown in Figure 68.
6. Install the right side base piece on top of the right side mesh guard as shown in Figure 69. The base pieces, in addition to adding an aesthetic dimension to the overall appearance, help to complete an enclosure for holding the ember pieces / glowing ember material pieces on top of the burners (Figure 70). The two side pieces have one hole each to accept the posts protruding from the bottom of logs two and four.



Figure 69: Right side base piece.



Figure 70: All three base pieces in place.

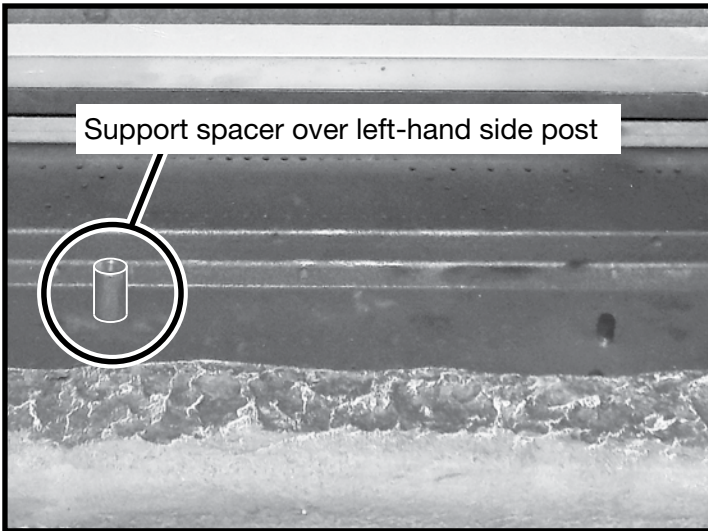

Figure 71: Support spacer over post.



Figure 72: 1st log placement.

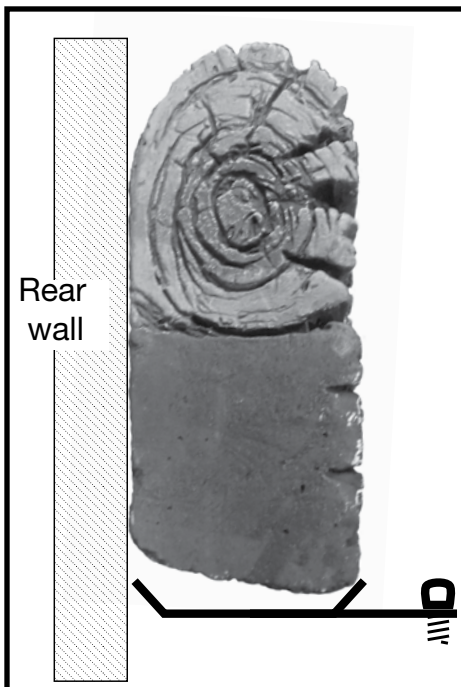

Figure 73: Log one position on air deflector - 1st log support.



Figure 74: Ember pieces spread on top of burner trays.

7. Place included metal spacer/support over top of the left-hand side post located on the front burner (Figure 71). This spacer will support the front tip of log number two. **Note: Spacer may already be present and pre-fastened to the burner.**
8. Place the number one log on top of the air deflector / 1st log support (Figure 72) making sure that the back side of this log is up against the rear wall (Figure 73).
9. Distribute a thin layer of ember pieces (Figure 58) onto the front and rear burner trays (Figure 74). Place extra ember pieces on the thin, but noticeable gaps between the front base piece and the two side base pieces (Figure 75). Keep the ember pieces from interfering with the pilot assembly. Keep the ember pieces from falling into the air gaps between the front and rear burners and the gap between the rear burner and the air deflector which supports the first log (Figure 76).

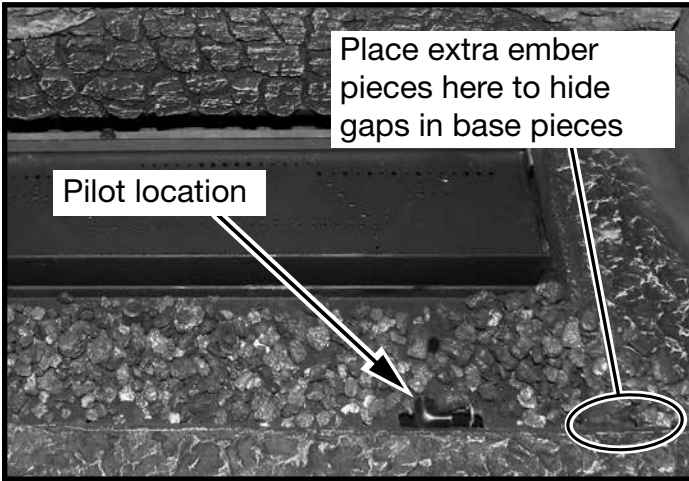

Figure 75: Ember pieces surrounding pilot.

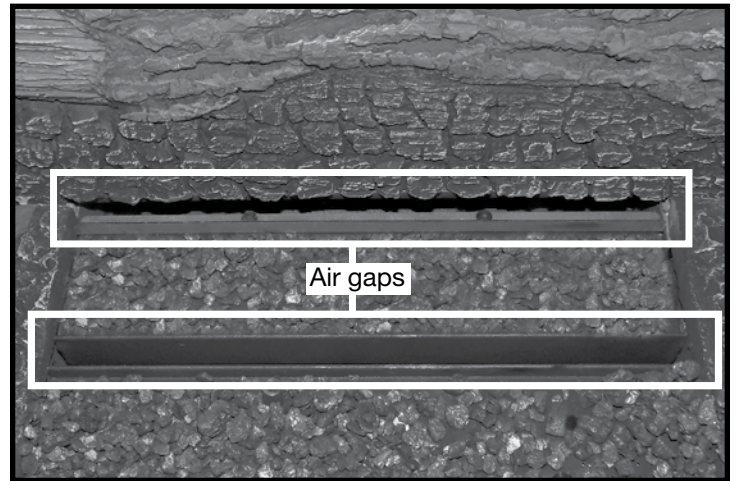

Figure 76: Air gaps.

10. Place log number two (Figure 53) so that the post protruding from the bottom of the log can be inserted into the hole of the left base piece. Then position the front tip of the log so that it rests on top of the spacer (Figure 77). The log and the ember pieces should ideally hide the spacer.
11. Place log number three (Figure 54) so that the post protruding from the bottom of the log can be inserted into the hole of the right-hand base piece. Then position the front of the log so that it rests on top of the center base piece (Figure 78). The front tip of the log should be very close to, or just touching, the center base piece.
12. There is a location post on top of the 3rd log (Figure 78) that is used to accommodate a slot located on the bottom of the 4th log (Figure 55). Place the 4th log's slot on top of the 3rd log's post. Position the front (or lower) end of the 4th log so that it sits on the rear edge of the front burner as shown in Figure 79.
13. Place the 5th log (Figure 56) so that the bottom end of the log rests against the right wall panel and on top of the front base piece. Position the upper end so that the longer branch is cradled in the crook of the 4th log (Figure 80). Position the lower end so that it is on top of the front base piece close to where the door glass will be.

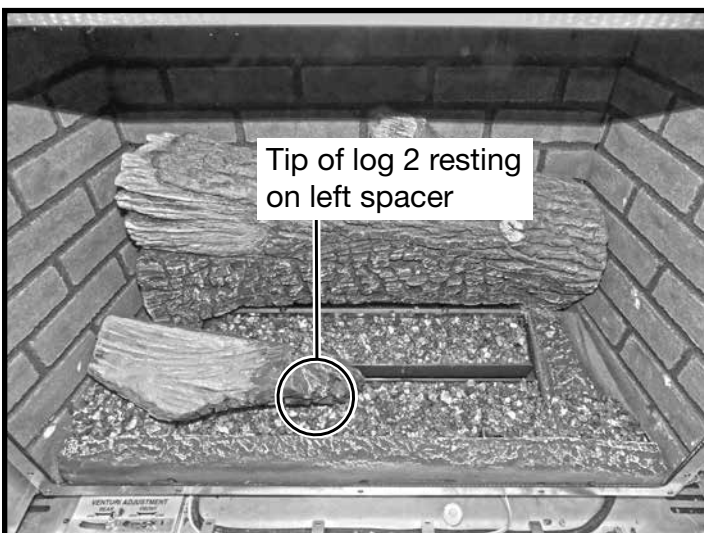

Figure 77: Log 2 positioned on spacer.

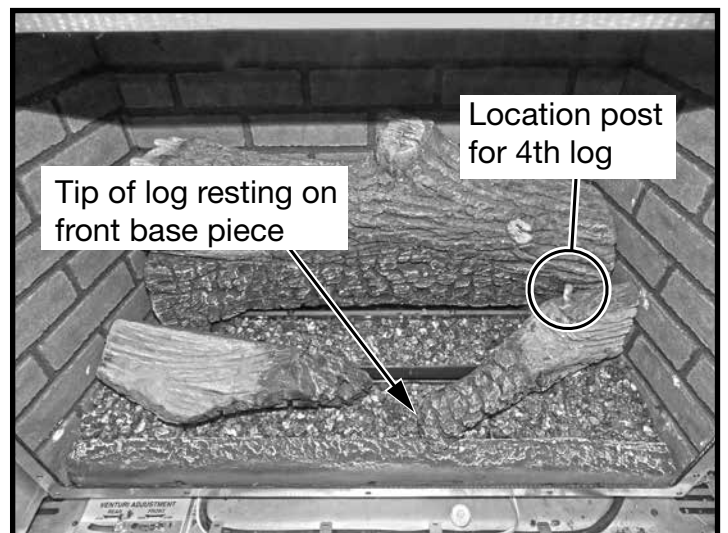

Figure 78: Log 3 placement and location post for log 4.



Figure 79: 4th log placement.



Figure 80: 5th log placement.

14. Place the 6th log (Figure 57) so that the top end rests on top of the 2nd log and the bottom end rests against the left wall panel and left base piece (Figure 81). The bottom end should be close to the front edge of the left base piece but not so close that it will be disturbed when re-installing the fireplace door.
15. Left over ember pieces can be used to hide the edges of the base pieces in addition to placing some on top of the base pieces if desired.
16. Gently pull apart the individual pieces of the ember wool (Figure 59) so that they are not compressed or compacted and spread them in front of the logs to finish (Figure 81).

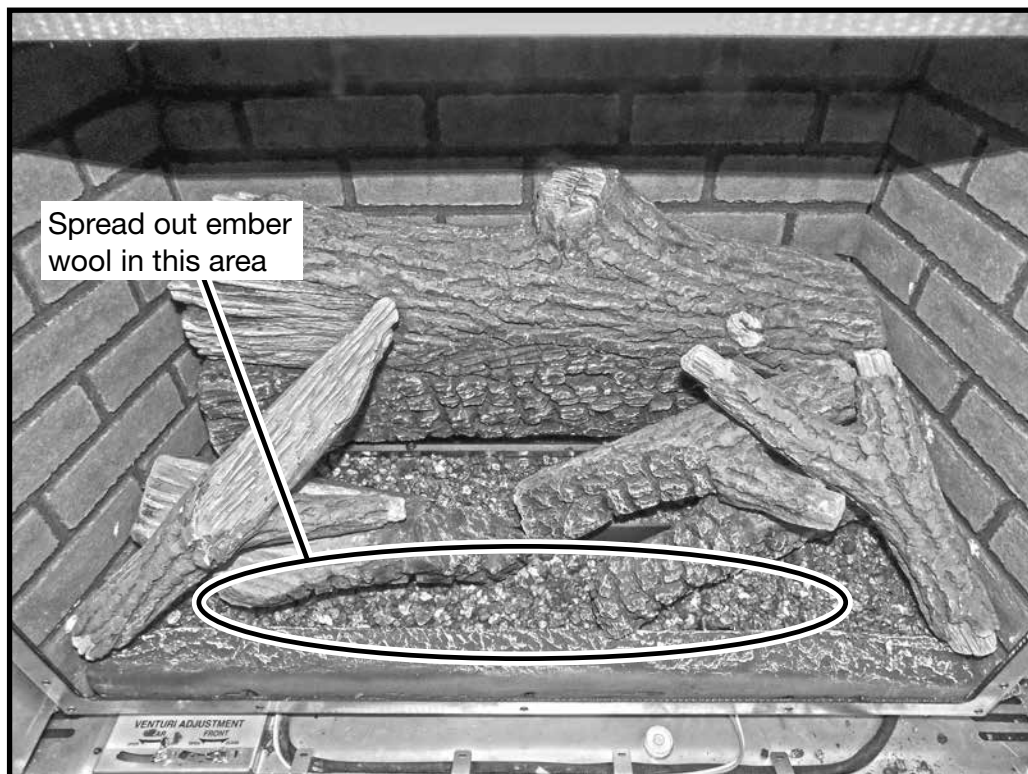

Figure 81: 6th log placement and ember wool distribution.



## Manual Switch Installation for SIT Units

The manual ON/OFF switch for the fireplace comes semi-installed (Figure 83). All that is needed is to install the switch itself to the surround backing plate.

### To install ON/OFF Switch

1. Check that the ON/OFF Switch cable is plugged into the SIT module (jack X8) as shown in Figure 82.

**Note regarding batteries for the SIT module (Figure 82):** Installation of batteries for the SIT module are not necessary if the fireplace is connected to AC power. Batteries are only used if the fireplace is not connected to AC power and as a backup against power failure.

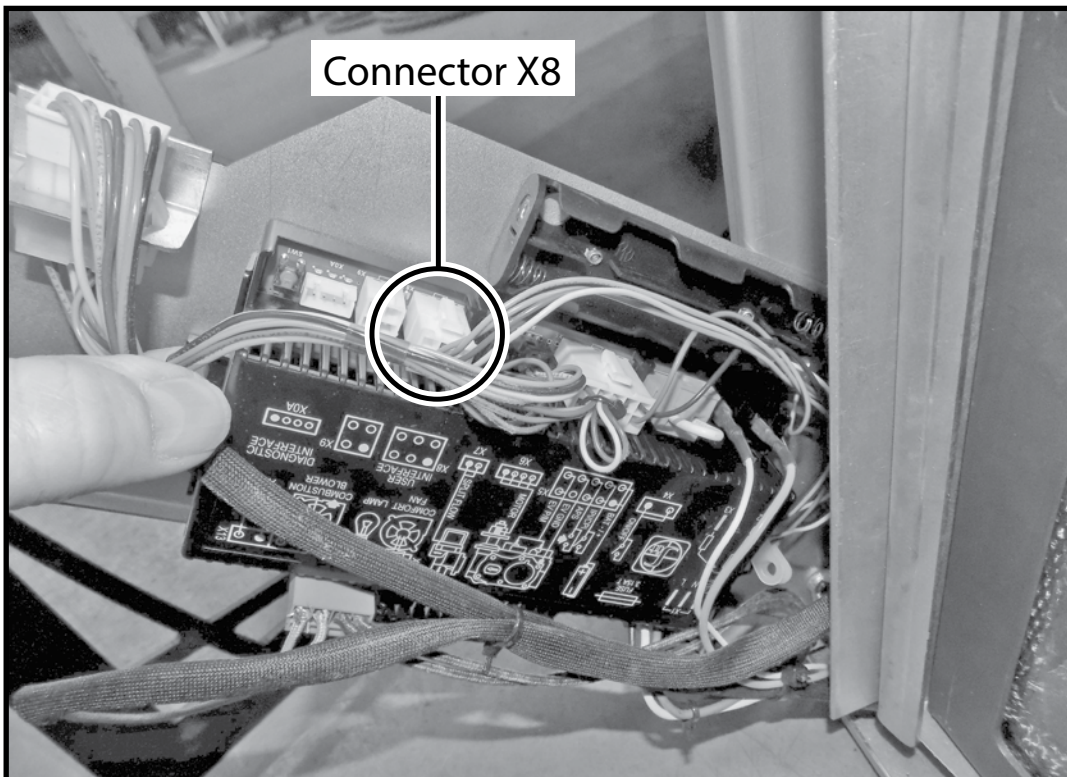

Figure 82: SIT manual switch connection at SIT module.

2. With the surround backing plate positioned in front of the fireplace, position the switch in behind the open slot in the backing plate and screw into place Figure 84.

**Note: The SIT remote handset and receiver can be paired at this time before the surround backing plate and surround are installed in their final locations. See “Pairing the SIT Remote Handset and Receiver” on page 35 for instructions.**

3. Install the surround backing plate and surround.

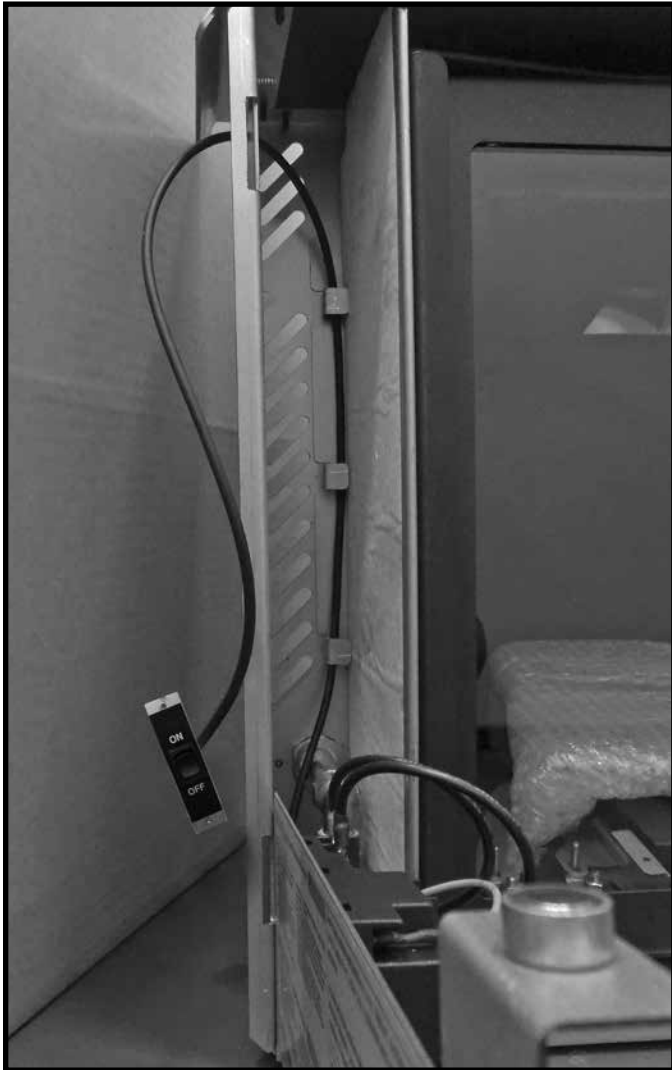

Figure 83: Pre-installed ON OFF switch SIT assembly.

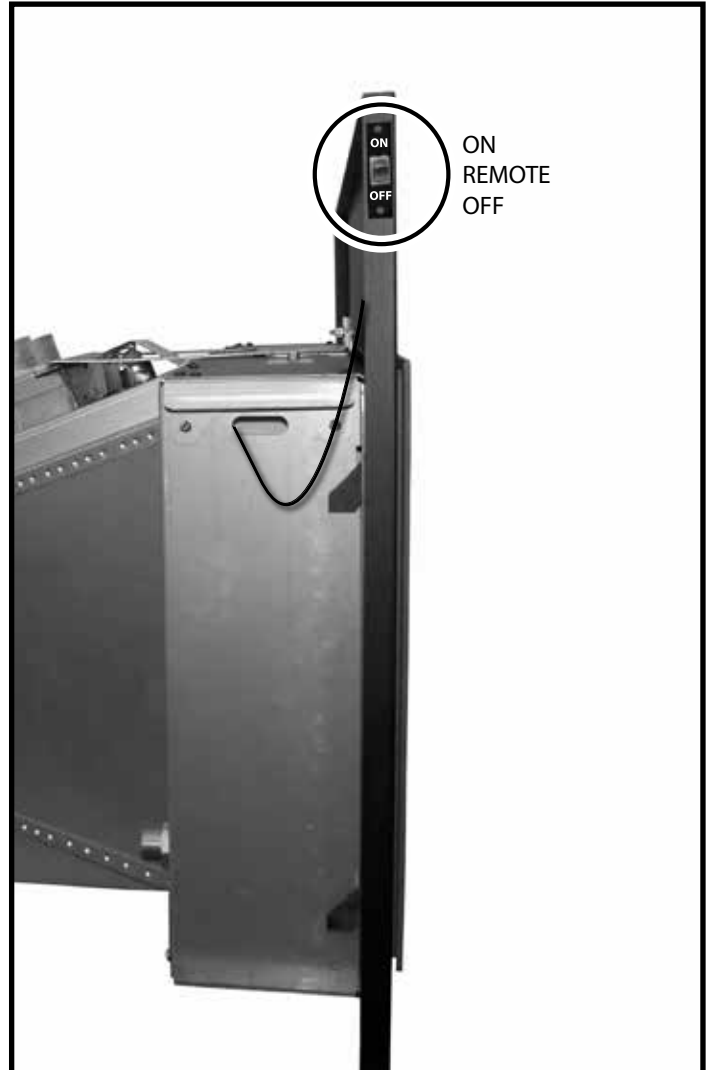

Figure 84: On Off switch for SIT units.

## Pairing the SIT Remote Handset and Receiver

1. Install 4 AA batteries into the battery holder located behind the electronic control module on the pull - out caddy (Figure 85). Note: Batteries are not required if the fireplace is connected to an AC power source.
2. Install 3 AAA batteries into the SIT remote handset (Figure 86)
3. Plug the power cord into the Tofino and open the gas supply line.
4. With the decorative front and backing plate (Figure 88 and Figure 89) removed, press the button marked “PRG” on the caddy and press the program button once (Figure 87). The module will beep 3 times indicating that it is ready to synchronize with the remote handset.
5. On the remote handset, push the power on button once. The remote handset will beep 4 times to indicate that the remote handset and the control module are now synchronized. The remote handset is now ready to use.

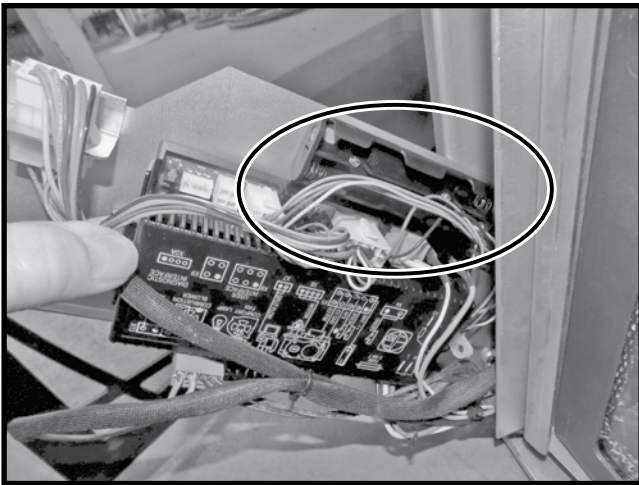

Figure 85: SIT module battery holder.



Figure 86: SIT remote handset and battery holder.

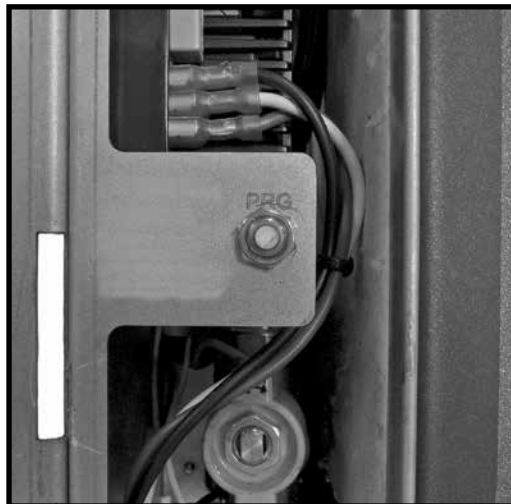

Figure 87: Program button.

## Surround Installation/Removal Instructions

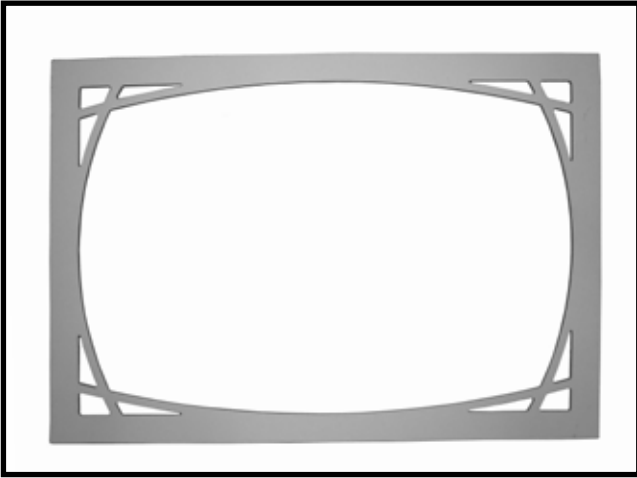

Figure 88: Decorative front.

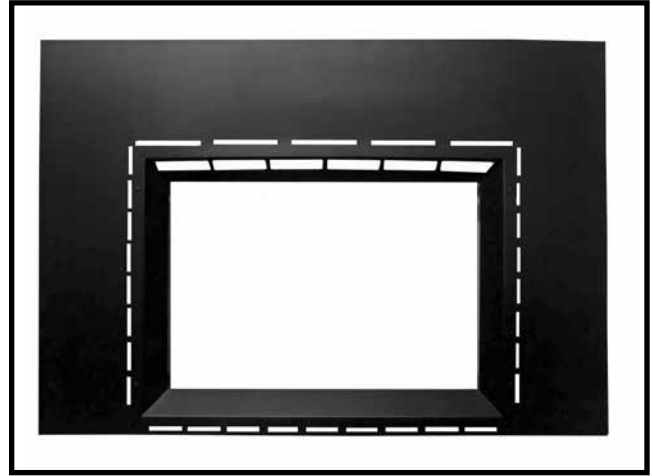

Figure 89: Backing plate.

### Installation

1. Attach the ON/OFF Switch face plate to the backing plate before seating the backing plate onto the fireplace.
2. Place the backing plate onto the fireplace by inserting its four hooks into the four slots on the fireplace frame (Figure 90).
3. Install the decorative front by inserting its four hooks into the corresponding slots on the backing plate (Figure 91).

### Removal

Removal is the reverse of installation.

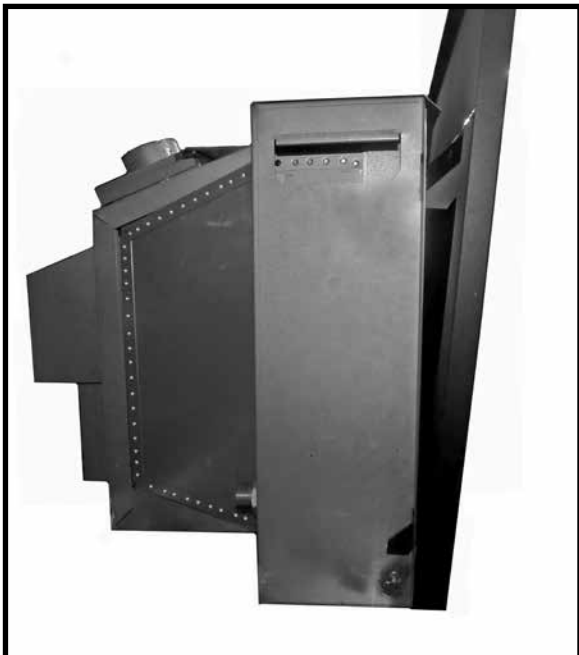

Figure 90: Mounting the backing plate.



Figure 91: Mounting the decorative front.

# Lighting Instructions

## FOR YOUR SAFETY READ BEFORE LIGHTING

**WARNING:** If you do not follow these instructions exactly, a fire or explosion may result causing property damage, personal injury or loss of life.

- A. This appliance is equipped with an ignition device which automatically lights the pilot. Do not try to light the pilot by hand.  
 B. BEFORE LIGHTING smell all around the appliance area for gas. Be sure to smell next to the floor because some gas is heavier than air and will settle on the floor.  
**WHAT TO DO IF YOU SMELL GAS:**  
 - Do not try to light any appliance.  
 - Do not touch any electric switch; do not use any phone in your building.

- Immediately call your gas supplier from a neighbour's phone. Follow the gas supplier's instructions.  
 - If you cannot reach your gas supplier, call the fire department.  
 C. Use only your hand to push in or turn the gas control knob. Never use tools. If the knob will not push in or turn by hand, don't try to repair it; call a qualified service technician. Force or attempted repair may result in a fire or explosion.  
 D. Do not use this appliance if any part has been under water. Immediately call a qualified service technician to inspect the appliance & to replace any part of the control system & any gas control which has been under water.

## LIGHTING INSTRUCTIONS

- STOP! Read the safety information above on this label.
- This appliance is equipped with an ignition device which automatically lights the pilot. Do not try to light the pilot by hand.
- Push the "On/Off" switch to turn the fireplace ON.  
 - If the burner does light go to step 6.  
 - If the burner does not light, complete steps 4 through 5.  
 - If the burner will not light or stay lit after several tries, push the "On/Off" switch for the fireplace to OFF, turn off all electric power to the fireplace and call your service technician or gas supplier. Note: Sufficient time must be allowed for air to escape from lines if the unit is being lit for the first time.
- Push the "On/Off" switch to the fireplace Off.
- Allow sufficient length of time (minimum 5 minutes) for any gas in the combustion chamber to escape. If you still smell gas, STOP! Follow "B" in the safety information above on this label. If you don't smell gas, go to step 3.
- Set fireplace to desired setting by using hand held remote.

## TO TURN OFF GAS APPLIANCE

- Push the "on/ off" switch to the "OFF" position.
- Turn off all electric power to the appliance and remove backup batteries if service is to be performed or for extended shutdown.

Due to high surface temperatures, keep children, clothing and furniture away. Keep burner and control compartment clean. See installation and operating instructions accompanying the appliance.

A cause de la temperature elevee des parois, tenir eloignes les enfants, les vetements et les meubles. Maintenir propres le brûleur et le compartiment de commande. Voir les instructions relatives a l'installation et au fonctionnement qui accompagnent l'appareil.

**CAUTION:** Hot while in operation. Do not touch. Severe burns may result. Keep children, clothing, furniture, gasoline and other liquids having flammable vapours away. Keep burner and control compartment clean. See installation and operating instructions accompanying the appliance.

**ATTENTION** L'appareil est chaud lorsqu'il fonctionne. Ne pas toucher l'appareil. Risque de brûlures graves. Surveiller les enfants. Garder les vêtements, le meubles, l'essence ou autres liquides produisant des vapeurs inflammables loin de l'appareil. S'assurer que le brûleur et le compartiment des commandes sont propres. Voir les instructions d'installation et d'utilisation qui accompagnent l'appareil.

5052.980-A

The lighting instructions label is located on the back of the gas valve controller caddy (Figure 92). It is accessed by removing the surround and then pulling the caddy out to reveal the lighting instruction label.

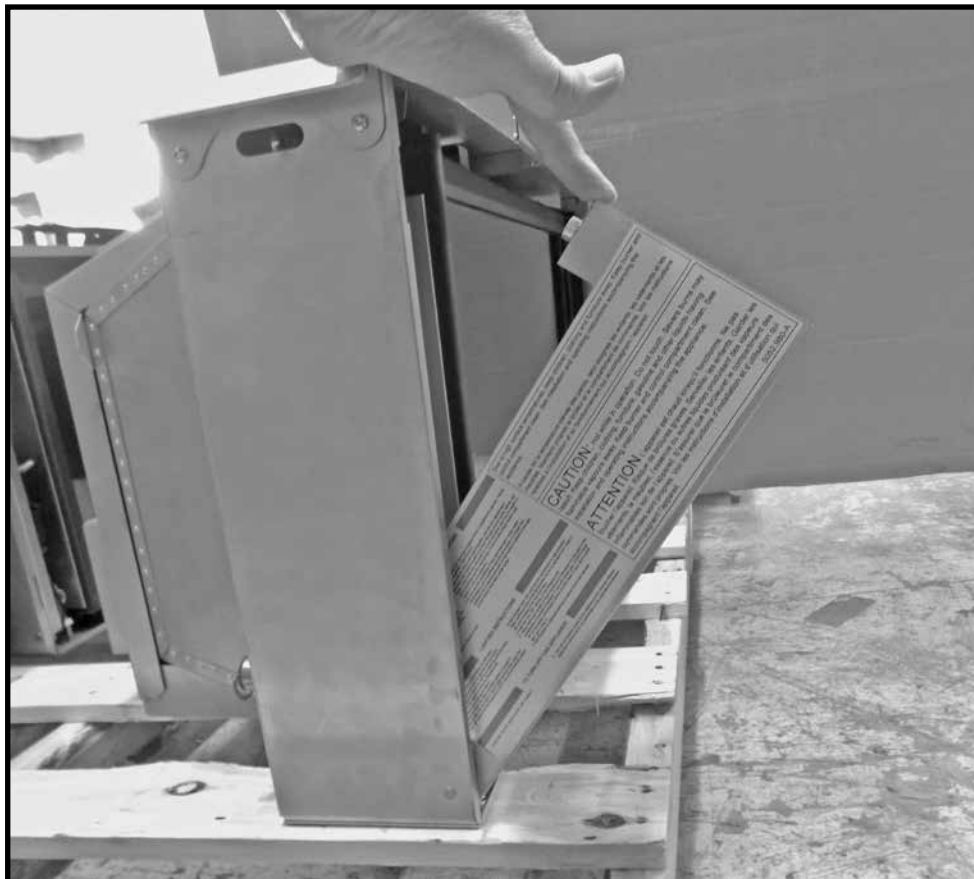

Figure 92: Lighting instructions label location.

# Maintenance

## CAUTION:

Turn off gas and electrical power supply (if applicable) and allow ample time for unit to cool before servicing appliance. It is recommended that the fireplace and its venting should be inspected at least once a year by a qualified service person.

## Glass Door:

Warning: Do not operate fireplace with glass door removed, cracked or broken. Replacement of the glass door should be done by a licensed or qualified service person.

Do not strike or otherwise impact the glass in anyway that may cause it to break. If the glass becomes cracked or broken it must be replaced before using the fireplace. Replacement door can be obtained from your nearest Pacific Energy Fireplaces dealer. The size required is dependent on which version of Tofino is installed. Use original Tofino door only. Do not substitute with any other type.

To remove broken glass, remove door frame as noted in See "Door Installation/Removal" on page 15.

Install the new door onto the fireplace.

## Annual Inspection:

- Remove glass door and inspect if soot buildup is present. Inspect the burner assembly and the ceramic glass baffle for soot buildup. If excessive buildup of soot is present, have a qualified service person inspect and adjust unit for proper combustion. Clean logs and burner with a brush or vacuum cleaner, paying close attention to burner ports.
- Check the pilot system for proper flame size and operation. Clean pilot free of soot, dust or any other deposits (Figure 93 and Figure 94). Have a qualified service person adjust the pilot flame.
- Check that the vent pipe and vent terminal are open and free from blockage or debris. If the venting is disassembled for cleaning, it must be properly assembled and re-sealed. See Venting section in Installation manual proper procedure.
- Check glass panel gasket, replace the door if necessary. It is important that the glass seal be maintained in good condition.
- Check and replace batteries as needed.

Note: The appliance area must be kept clear and free from combustible materials, gasoline and other flammable vapours and liquids.

## Periodically:

- Viewing glass may be cleaned as necessary with fireplace glass cleaner.
- Exterior finish may be cleaned with mild soap and water.

## CAUTION:

Do not use abrasive cleaners on glass or any other part of the fireplace. Do not clean glass when hot.

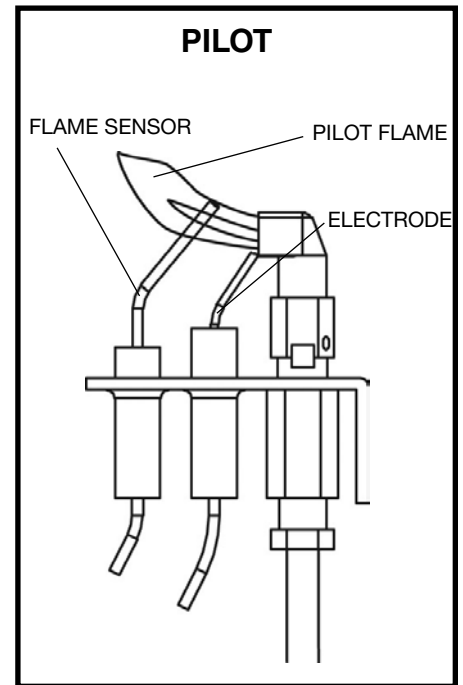

Figure 93: SIT pilot assembly.

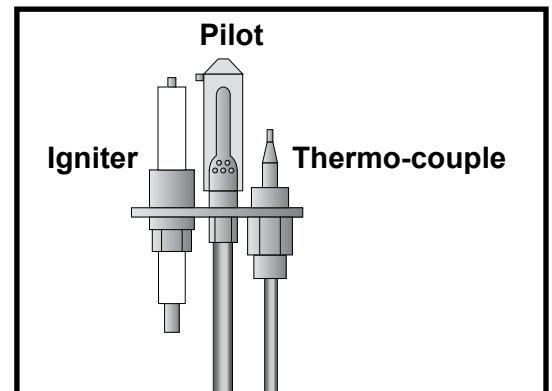
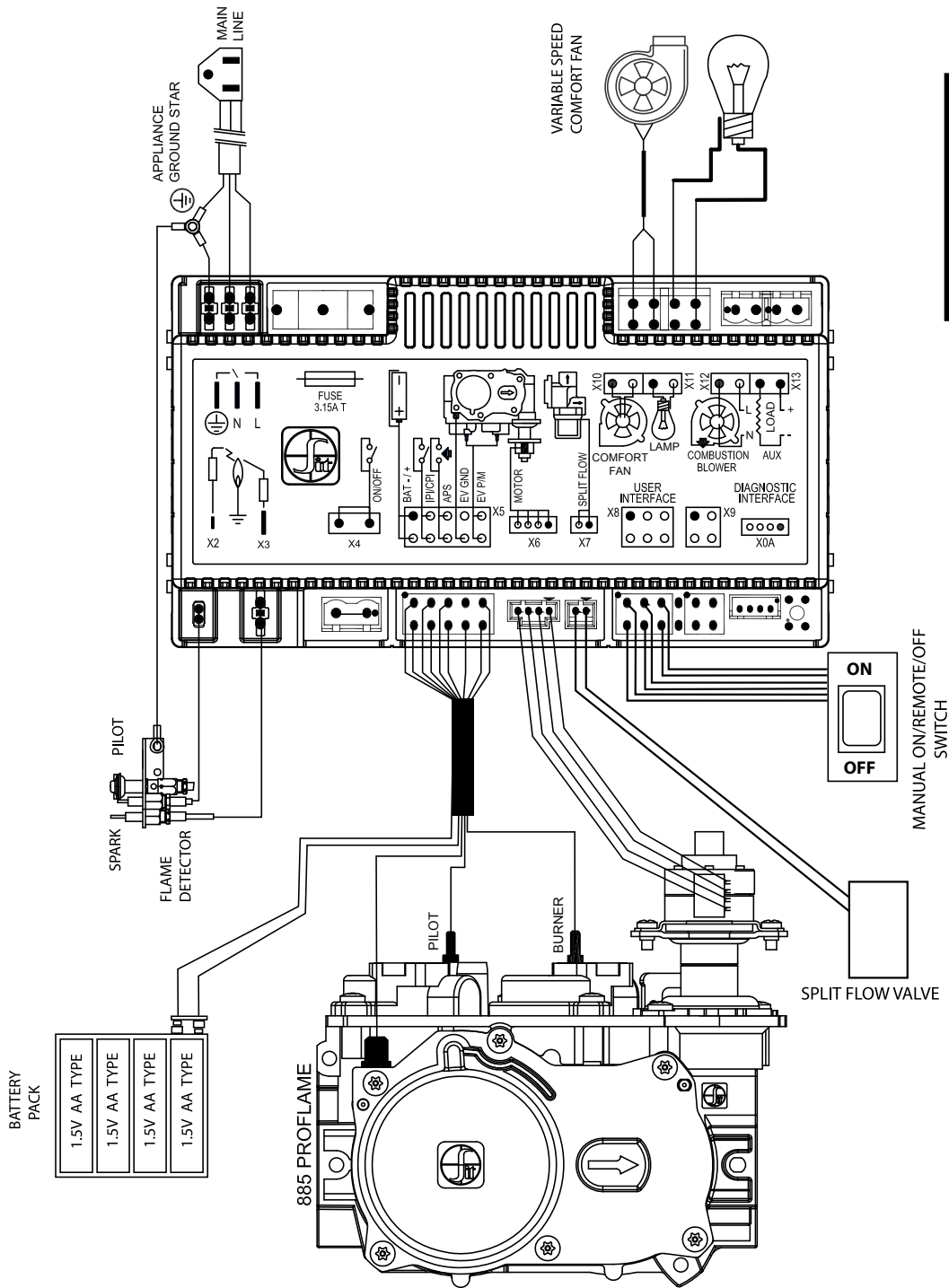

Figure 94: Maxitrol pilot.

# Wiring Diagram for SIT Proflame



**Caution: Label all wires prior to disconnection when servicing controls. Wiring errors can cause improper and dangerous operation. Verify proper operation after servicing.**

Figure 95: SIT wiring diagram.

# Tofino i30 Rating Label

## SIT Version

**WARNING:** Improper installation, adjustment, alteration, service or maintenance can cause injury or property damage. Refer to the owner's information manual provided with this appliance. For assistance or additional information, consult a qualified installer, service agency or the gas supplier. **AVERTISSEMENT:** Une installation, un réglage, une modification, une réparation ou un entretien mal effectués peut causer des dommages matériels ou des blessures. Voir la notice de l'utilisateur qui accompagne l'appareil. Pour de l'aide ou des renseignements supplémentaires, consultez un installateur, un technicien agréé ou le fournisseur de gaz.

This appliance equipped for altitudes 0 - 4500 ft. (0 - 1372 m) / Cet unité est conçue pour des altitudes variant entre 0 - 4500 pieds (0 - 1372 m). In Canada, also certified for installation in a bedroom or a bed sitting room / Aussi certifié pour installation dans une chambre à coucher ou une salle de séjour. This appliance must be installed in accordance with local codes, if any; if none, follow the current CAN/CGA-B149 (Canada), or ANSI Z223.1 (USA) Installation Codes. Installer l'appareil selon les codes ou règlements locaux, ou, en l'absence de tels règlements, selon les codes d'installation CAN/CGA-B149 (Canada), or ANSI Z223.1 (USA) en vigueur.

Electrical Rating: 115VAC, 60Hz, 0.7A / Normes Électriques: 115VAC, 60Hz, 0.7A



MODEL / MODELE:  
**TOFINO i30s**

SERIES/  
SERIE: **A**



MADE IN CANADA  
FABRIQUE AU CANADA

5050.930-A Tofino i30s 021216

**VENTED GAS FIREPLACE - NOT FOR USE WITH SOLID FUEL**

**FOYER AU GAZ À ÉVACUATION - NE PAS UTILISER AVEC DU COMBUSTIBLE SOLIDE**

ANSI Z21.88-2016 / CSA 2.23-2016 Vented Gas Fireplaces/Heaters. CAN/CGA 2.17-M91 Gas-Fired Appliance For Use At High Altitudes.

Certified for / Certifié pour Canada and U.S.A.

217

This Appliance is Equipped For Use With / Cet Appareil est Équipé Pour Utiliser Avec :

**NATURAL GAS**  **LP-GAS**   
**GAZ NATUREL**  **LP GAZ**

FOR USE WITH/ EN CASE D'EMPLOI AVEC:	NATURAL GAS/ DU GAZ NATUREL	LP GAS/ DU GAZ LP
Minimum supply pressure / Pression minimum d'alimentation: (For the purpose of input adjustment / dans le but de régler l'alimentation) Maximum supply pressure / Pression maximum d'alimentation:	5.0 in/wc / 5.0 po/c.e. (1.25 kPa) 13.9 in/wc / 13.9 po/c.e. (3.45 kPa)	12.5 in/wc / 12.5 po/c.e. (3.11 kPa) 13.9 in/wc / 13.9 po/c.e. (3.45 kPa)
Manifold pressure / Pression de la tuyauterie: Maximum	3.5 in/wc / 3.5 po/c.e. (0.95 kPa)	10.0 in/wc / 10.0 po/c.e. (2.74 kPa)
Orifice Size / Diametre de l'injecteur:	Front: AB, Rear: BB	Front: CB, Rear: DB
Input BTU/hr (kW) / Entree BTU/h (kW):	Max. 30,000 (8.79) Min. 9,000 (2.63)	Max. 30,000 (8.79) Min. 10,500 (3.07)

**MANUFACTURED (MOBILE) HOME:** This appliance is only for use with the type of gas indicated on the rating plate and may be installed in an aftermarket, permanently located, manufactured (mobile) home where not prohibited by local codes. See owners manual for details.

**FABRIQUEZ (MOBILE) MAISON:** Cet appareil doit être utilisé uniquement avec le type de gaz indiqué sur la plaque signalétique et peut être installé dans une maison préfabriquée (mobile) installée à demeure si les règlements locaux le permettent. Voir la notice du propriétaire pour plus de détails. Cet appareil ne peut être converti à d'autres gaz sauf si une trousse de conversion certifiée est utilisée. Install in accordance with the current standard Mobile Homes, CAN/CSA Z240 MH (in CANADA), and the Manufacturer's Home Construction and Safety Standard, Title 24 CFR, Part 3280, or the current Standard for Fire Safety Criteria for Manufactured Home Installations, Sites, and Communities ANSI/NFPA 551A, (in the U.S.A.). Cet appareil doit être installé conformément aux exigences de la norme CAN/CSA Z240 MH en vigueur de l'ACNOR, Installations de gaz dans les Constructions Mobiles.

**FOR USE WITH THE GLASS AND SCREEN BARRIER CERTIFIED WITH THE APPLIANCE ONLY / POUR UTILISATION UNIQUEMENT AVEC LES PORTES EN VERRE CERTIFIÉES AVEC L'APPAREIL**

**Clearance to combustibles**

Bottom of appliance to 14" mantel:	35"
Center of appliance to side wall:	18"
Hearth in front of appliance:	0"
Under appliance:	0"
Objects in front of appliance:	36"



i30 TOFINO

40

160323-44

100000330



## Rating label location

The rating label for the Tofino is located on the left-hand outside wall of the insert.



Figure 96: Rating label location.





© 2023 Copyright Pacific Energy Fireplace Products LTD.

Reproduction, adaptation, or translation  
without prior written permission is prohibited  
except as allowed under the copyright laws.



**For technical support, please contact your retailer**

**Web site: [www.pacificenergy.net](http://www.pacificenergy.net)  
2975 Allenby Rd., Duncan, BC V9L 6V8**

Printed in Canada